

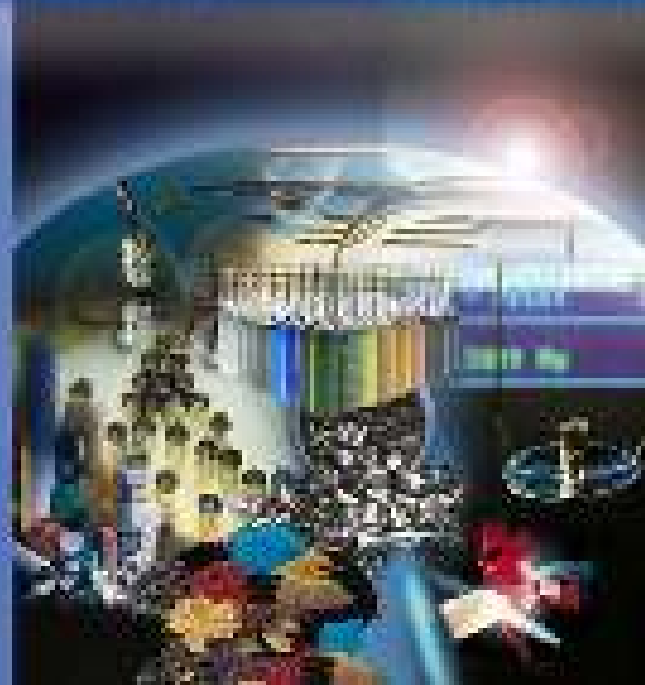

CATALOGUE

 **Elemental
Microanalysis**

The definitive product guide for CHNOS analysis



Ordering Information

We are happy to accept orders by any of the following methods:

Phone: +44 (0)1837 54446

Fax: +44 (0)1837 54544

E-mail: info@microanalysis.co.uk

Mail: Elemental Microanalysis Ltd
1 Hameldown Road
Okehampton Business Park
Okehampton
Devon EX20 1UB
United Kingdom

We can invoice you in Sterling, Euro or US Dollar and accept Visa, Mastercard and American Express, account facilities are readily available for regular customers, please enquire.

Shipping worldwide

We regularly ship directly to customers in all parts of the world. Local dealers are available in many countries: contact us for details.



www.microanalysis.co.uk

Available locally from:

Other literature available from Elemental Microanalysis

In addition to this catalogue a range of other catalogues and product sheets are available:

Catalogues

We publish catalogues covering the following areas of elemental analysis:

- Nitrogen/Protein
- Carbon/Sulphur
- Inorganic
- Organic Elemental (CHN/O/S)



Product sheets

Product sheets are available for every instrument we support, and cover all the common day-to-day items required to run your instrument. These sheets are printed on special durable paper to help them survive in the lab environment.



Contract analysis service

We also offer a contract analysis service for a variety of (mainly) organic compounds. Full details are in this brochure.



All literature is available using the 'faxback' form on the rear cover of this catalogue or can be downloaded from our website.

<p>2 Introduction</p> <hr/> <p>5 Pressed Capsules for solid samples</p> <p>7 Ultra-Clean Pressed Capsules for solid samples</p> <p>8 Pressed Weighing Pans for solid samples</p> <p>10 Aluminium Pans for moisture determination Nickel Boat Liners Tin Foil Evaporating Cups</p> <p>11 Foil Discs and Squares for sample encapsulation</p> <p>13 Smooth Wall Tin Capsules</p> <p>15 Weighing Boats for liquid and solid samples</p> <hr/> <p>16 Standards</p> <hr/> <p>REAGENTS</p> <p>18 Combustion Catalysts and Reagents</p> <p>19 Platinum/Nickel Catalysts</p> <p>20 Copper Reduction Reagents Reagents for Isotope Analysis</p> <p>21 Interference Removal Reagents Pyrolysis Catalysts and Reagents</p> <p>22 Miscellaneous Materials, Combustion Aids Gas Doping Reagents</p> <p>23 Column Packings, Absorbent Materials Scrubbing and Purification Reagents</p> <hr/> <p>GLASSWARE</p> <p>24 Carlo Erba/ThermoFinnigan 1108/1110/1500(2)/2500</p> <p>25 Carlo Erba/ThermoFinnigan Flash EA™ 1112</p> <p>26 Carlo Erba/ThermoFinnigan 1500 Series 1</p> <p>27 Carlo Erba/ThermoFinnigan 1106 Costech</p> <p>28 Elementar Vario EL Elementar CHN Rapid</p> <p>29 Perkin Elmer 2400 Leco® 900/932</p> <p>30 Europa Eurovector</p> <p>31 Exeter</p> <hr/> <p>O-RINGS</p> <p>32 Carlo Erba/ThermoFinnigan</p> <p>33 Eurovector Perkin Elmer</p> <p>34 Leco® Elementar</p> <p>36 Costech Europa Exeter</p> <hr/> <p>37 Separation Columns</p> <hr/>	<p>MISCELLANEOUS SUPPLIES</p> <p>38 Oxygen Flask Combustion Equipment</p> <p>39 Microanalytical Tools and Sundries</p> <hr/> <p>41 CONFIGURATION GUIDE</p> <p>42 Europa</p> <p>44 Costech</p> <p>46 ThermoFinnigan/CE/Fisons/Carlo Erba 1108</p> <p>47 ThermoFinnigan/CE/Fisons/Carlo Erba 1110</p> <p>48 ThermoFinnigan/CE/Fisons/Carlo Erba 1500 mk II</p> <p>49 ThermoFinnigan/CE/Fisons/Carlo Erba 1500 mk I</p> <p>50 ThermoFinnigan/CE/Fisons/Carlo Erba NA2500</p> <p>51 ThermoFinnigan/CE/Fisons/Carlo Erba 1106</p> <p>52 ThermoFinnigan/CE/Fisons/Carlo Erba Flash EA™ 1112</p> <p>54 Eurovector EA3000 - 18/6 Tubes</p> <p>56 Eurovector EA3000 - Straight Tubes</p> <p>59 Elementar Vario EL</p> <p>60 Elementar (Foss-Heraeus) CHN Rapid</p> <p>62 Perkin Elmer 2400</p> <p>63 Leco® CHN-900 Leco® CHNS-932 Leco® 900/932 Gas Scrubbing Tube</p> <hr/> <p>CROSS-REFERENCE</p> <p>64 ThermoFinnigan/CE/Fisons/Carlo Erba</p> <p>65 Leco®</p> <p>66 Perkin Elmer</p> <p>67 Europa Exeter</p> <p>68 Costech Elementar</p> <p>69 Eurovector</p> <hr/> <p>Inside back cover: Faxback form for literature request</p>
---	--

About the Company

Elemental Microanalysis grew from small beginnings almost 30 years ago as a micro-analytical laboratory to its current form as a leading manufacturer and supplier of consumables, supplies and other products for Elemental Analysers. We operate from our purpose-built factory and laboratory complex in Devon UK.

You learn a lot in 30 years - a lot about your products - how to make them and how to use them, a lot about your customers and their needs. We have been developing, refining and using products for elemental analysis since 1976 and have a unique in-depth knowledge of instruments from all manufacturers.

These days we offer the world's largest range of products for elemental analysers sending our products to customers across the globe.

We take great care with the quality of our products. The vast majority are manufactured in-house by our trained technicians within our ISO 9001:2000 accredited quality system. But we don't just make the products - we use them every day in our own analytical laboratory giving

us constant feedback on their performance. We do not compromise on quality and don't expect you to either. Our total satisfaction guarantee backs up our commitment to our product quality.

'Price is what you pay, value is what you get'. As the leading independent supplier of elemental analysis consumables you can achieve substantial savings in comparison to the prices charged by the original supplier of your instrument. But we know that you need more from a supplier than simply low prices. You need to buy with the confidence that your analysis will not be compromised by poor quality consumables and the knowledge that your supplier has all the resources to provide the full range of support that you expect.

We will always treat our customers with honesty and integrity. If we do make a mistake we don't try to hide it - we recognise it and put it right.

We won't sell you short measure and we won't mislead you in any way. Our business is built on long-term relationships as our customers will testify - many have been with us for more than 20 years.



Guaranteed quality

Our quality system is certified to BS EN ISO 9001:2000 by LRQA under certificate no 956566 and is regularly audited by independent specialists. Our confidence in our products allows us to offer you a total satisfaction guarantee: if our product does not perform at least as well as the product brand you usually use you can return it for a full refund.



Try our products - free of charge!

Try before you buy - we have sample packs available for most elemental analysers on the market. Just let us know the instrument you have and we will send you a trial quantity of 3-4 different consumables to try - free and with no obligation. Offer limited to one per customer.

Sales service

Our sales staff will ensure that your order is despatched promptly and correctly. They can tell you about our stock levels, prices, shipping arrangements, or answer any other queries you may have.

Most orders are despatched within 24 hours of receipt. Rush orders receive special attention and are processed immediately. If you have an urgent problem or require priority despatch, please let us know.

Technical service

In this catalogue we have tried to provide the most accurate and complete information possible about our ever-expanding range. We realise, however, that you may require additional technical information. For this reason we have technical specialists on hand to answer your questions and advise you on selecting the products best suited to your needs. We can also supply samples, and even develop new products for your particular application.

Design changes

We are constantly working on improving our products and these improvements may mean that some products differ from the descriptions in this catalogue. Our technical staff are happy to discuss any improvements made, and the resultant benefits.

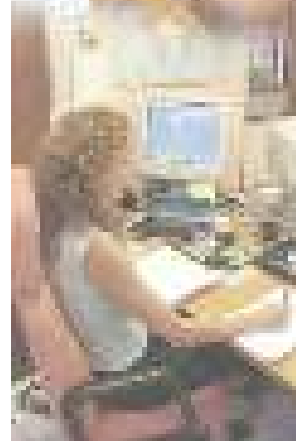

Terms and conditions of sale

The acceptance of any order is on the understanding that the purchaser agrees to the following Terms and Conditions of Sale:

Prices and orders

Prices can be confirmed by contacting our sales team. Both quoted and printed prices may be subject to alteration without notice. Order numbers are not required if payment can be made against invoice.

Quotations and invoices

Quotations are subject to confirmation on receipt of order. We reserve the right to amend any accidental errors or omissions.

Delivery

Although every effort will be made to honour delivery dates, no liability can be accepted if delays or non-delivery occurs.

Amendments or cancellations

Once an order is placed we consider it firm and only open to cancellation or amendment with our agreement.

Responsibility

Our responsibility is limited to the supply of goods of the type and quantity ordered and all consequential or resulting liability is expressly excluded.

Product origins

The vast majority of products are manufactured and packed in the UK by Elemental Microanalysis Ltd. The use of instrument names, instrument manufacturer names and part numbers does not imply that the products are of instrument manufacturer's origin.

Health, Safety and the Environment

We care about the effects our products may have on the health of our customers. Up to date health and safety information on relevant products (MSDS) is attached to the delivery note of every order.

Users are warned to examine and test goods and to exercise special care in cases where the use or storage of goods involves danger to people or property.

Particular care is needed with glass equipment and chemicals. We cannot accept liability for and injury or damage caused in any circumstances.

Our location, on the edge of the beautiful Dartmoor National Park, reminds us every day of our environmental responsibility. We are committed to the protection of the natural environment and ensure that any impact of our manufacturing activities is minimised.

We do not discharge hazardous effluents or atmospheric emissions in our manufacturing processes. We recycle waste metals, heat and most chemicals. Any materials that cannot be recycled are disposed of in a responsible manner. We operate a 'return to manufacturer' facility for safe disposal of used materials that we have supplied.



Elemental Microanalysis pressed capsules for solid samples are available in standard and ultra-light weights. They are manufactured to exacting standards ensuring consistently low blank values and uniform weight.

They can be used without any cleaning pre-treatment, but for critical samples solvent cleaning or the use of our ultra-clean capsules is recommended. They should not be ultrasonically cleaned as damage may result.

We can manufacture capsules in sizes and materials other than those listed below. We also offer discounts for larger quantities. Please enquire for details.

Pressed Tin Capsules

Elemental Microanalysis pressed tin capsules for solid samples are available in standard and ultra-light weights.

Standard weight

For routine use.

Diameter	Height	Weight	Pack	Cat no
2 mm	4.5 mm	8 mg	100	D1083
3.2 mm	4 mm	8 mg	500	D1000
3.2 mm	4 mm	8 mg	100	D1001
3.2 mm	5.25 mm	12 mg	100	D1109
3.2 mm	6.5 mm	17 mg	100	D1086
3.5 mm	3.75 mm	8 mg	100	D1087
3.5 mm	5 mm	12 mg	500	D1002
3.5 mm	5 mm	12 mg	100	D1003
3.5 mm	6.25 mm	17 mg	100	D1088
3.5 mm	8.75 mm	30 mg	100	D1089
4 mm	4.75 mm	12 mg	100	D1090
4 mm	6 mm	17 mg	500	D1006
4 mm	6 mm	17 mg	100	D1007
4 mm	8.5 mm	30 mg	100	D1091
5 mm	5.5 mm	17 mg	100	D1092
5 mm	8 mm	30 mg	250	D1008
5 mm	8 mm	30 mg	100	D1009
5 mm	12.5 mm	62 mg	200	D1010
6 mm	7.5 mm	30 mg	100	D1093
6 mm	12 mm	62 mg	200	D1012
6 mm	14 mm	82 mg	200	D1017
7 mm	7 mm	30 mg	100	D5047
7 mm	11.5 mm	62 mg	100	D1102
8 mm	11 mm	62 mg	100	D1103
8 mm	13.5 mm	82 mg	200	D1018
8 mm	20 mm	146 mg	100	D1011
9 mm	10.5 mm	62 mg	100	D1104
10 mm	10 mm	62 mg	100	D5055

Ultra-light weight

A range of ultra-light weight tin capsules weighing 40% less than the standard range. These lower weight capsules produce less swarf build-up in combustion tubes, have lower blank values and provide more available oxygen for effective combustion of samples.

Diameter	Height	Weight	Pack	Cat no
2 mm	4.5 mm	5 mg	100	D1084
3.2 mm	4 mm	5 mg	100	D1014
3.2 mm	5.25 mm	8 mg	100	D1108
3.2 mm	6.5 mm	11 mg	100	D1094
3.5 mm	3.75 mm	5 mg	100	D1095
3.5 mm	5 mm	8 mg	100	D1015
3.5 mm	6.25 mm	11 mg	100	D1096
3.5 mm	8.75 mm	19 mg	100	D1097
4 mm	4.75 mm	11 mg	100	D1098
4 mm	6 mm	11 mg	100	D1016
4 mm	8.5 mm	19 mg	100	D1099
5 mm	5.5 mm	11 mg	100	D1100
5 mm	8 mm	19 mg	100	D1013
5 mm	12.5 mm	39 mg	100	D1032
6 mm	7.5 mm	19 mg	100	D1101
6 mm	12 mm	39 mg	100	D1033
7 mm	7 mm	19 mg	100	D5208
7 mm	11.5 mm	39 mg	100	D1105
8 mm	11 mm	39 mg	100	D1106
9 mm	10.5 mm	39 mg	100	D1107
10 mm	10 mm	39 mg	100	D5216

Actual size

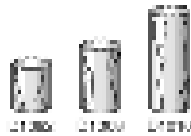
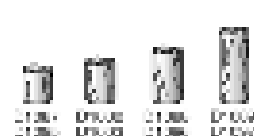
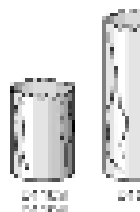

Actual size

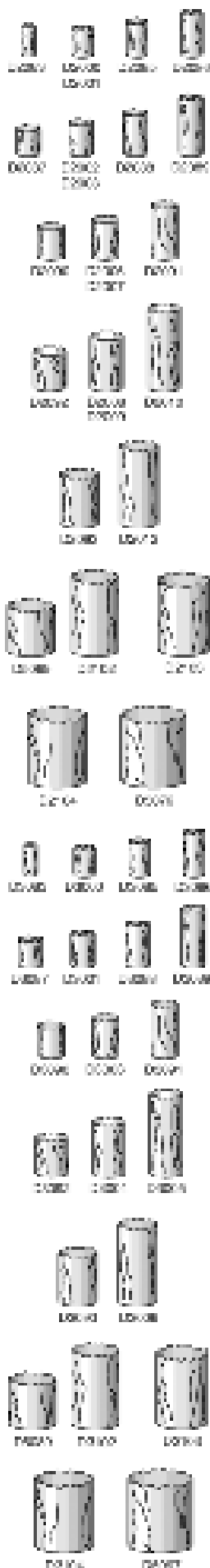

Pressed Silver Capsules

Silver capsules may become slightly oxidised or tarnished due to oxygen and contaminants in the air. This can easily be removed by heating to 375° C in air for one hour prior to use. They should be stored long term under an inert gas. For routine use.

Diameter	Height	Weight	Pack	Cat no
2 mm	4.5 mm	15 mg	100	D2083
3.2 mm	4 mm	15 mg	500	D2000
3.2 mm	4 mm	15 mg	100	D2001
3.2 mm	5.25 mm	22 mg	100	D2085
3.2 mm	6.5 mm	31 mg	100	D2086
3.5 mm	3.75 mm	15 mg	100	D2087
3.5 mm	5 mm	22 mg	100	D2003
3.5 mm	5 mm	22 mg	500	D2002
3.5 mm	6.25 mm	31 mg	100	D2088
3.5 mm	8.75 mm	54 mg	100	D2089
4 mm	4.75 mm	22 mg	100	D2090
4 mm	6 mm	31 mg	500	D2006
4 mm	6 mm	31 mg	100	D2007
4 mm	8.5 mm	54 mg	100	D2091
5 mm	5.5 mm	31 mg	100	D2092
5 mm	8 mm	54 mg	250	D2008
5 mm	8 mm	54 mg	100	D2009
5 mm	12.5 mm	110 mg	200	D2010
6 mm	7.5 mm	54 mg	100	D2093
6 mm	12 mm	110 mg	200	D2012
7 mm	7 mm	54 mg	100	D5069
7 mm	11.5 mm	110 mg	100	D2102
8 mm	11 mm	110 mg	100	D2103
9 mm	10.5 mm	110 mg	100	D2104
10 mm	10 mm	110 mg	100	D5076

Pressed Aluminium Capsules

For routine use.

Diameter	Height	Weight	Pack	Cat no
2 mm	4.5 mm	4 mg	100	D3083
3.2 mm	4 mm	4 mg	500	D3000
3.2 mm	5.25 mm	6 mg	100	D3085
3.2 mm	6.5 mm	8 mg	100	D3086
3.5 mm	3.75 mm	4 mg	100	D3087
3.5 mm	5 mm	6 mg	500	D3001
3.5 mm	6.25 mm	8 mg	100	D3088
3.5 mm	8.75 mm	14 mg	100	D3089
4 mm	4.75 mm	6 mg	100	D3090
4 mm	6 mm	8 mg	500	D3003
4 mm	8.5 mm	14 mg	100	D3091
5 mm	5.5 mm	8 mg	100	D3092
5 mm	8 mm	14 mg	250	D3004
5 mm	12.5 mm	27 mg	200	D3005
6 mm	7.5 mm	14 mg	100	D3093
6 mm	12 mm	27 mg	200	D3006
7 mm	7 mm	14 mg	100	D5089
7 mm	11.5 mm	27 mg	100	D3102
8 mm	11 mm	27 mg	100	D3103
9 mm	10.5 mm	27 mg	100	D3104
10 mm	10 mm	27 mg	100	D5097

Pressed Nickel Capsules

Elemental Microanalysis pressed nickel capsules are manufactured from high purity foil to exacting standards to ensure consistent low blank values and uniform weight. They can be used without any cleaning pre-treatment, but for critical work solvent cleaning or the use of pre-cleaned capsules is recommended.

For specialised applications.

Diameter	Height	Weight	Pack	Cat no
5 mm	12.5 mm	85 mg	100	D3500
5 mm	8 mm	38 mg	250	D3502
5 mm	8 mm	36 mg	250	D3503

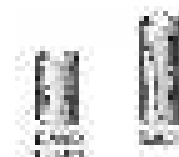

(D3503 has a 1 mm dia. hole in the bottom)

Elemental Microanalysis ultra-clean capsules are carefully solvent extracted then individually packaged in trays of 96 capsules ready for immediate use or in single packs of 250 (100 in the case of ultra-light tin capsules).

Tin capsules are available in standard and ultra-light weights.

Silver capsules may become slightly oxidised or tarnished due to oxygen and contaminants in the air. This can easily be removed by heating to 375°C in air for one hour prior to use.

Silver capsules should be stored long term under an inert gas.

We can manufacture capsules in sizes and materials other than those listed on this page. We also offer discounts for larger quantities. Please enquire for details.

Ultra-Clean Pressed Tin Capsules

Standard weight

Diameter	Height	Weight	Pack	Cat no
4 mm	6 mm	17 mg	96	D1027
4 mm	6 mm	17 mg	250	D1028
4 mm	6 mm	17 mg	10 x 96	D1112
5 mm	8 mm	30 mg	96	D1029
5 mm	8 mm	30 mg	250	D1034
5 mm	8 mm	30 mg	10 x 96	D1113
7 mm	7 mm	30 mg	48	D1037
7 mm	7 mm	30 mg	10 x 48	D1114

Ultra-light weight

Diameter	Height	Weight	Pack	Cat no
4 mm	6 mm	11 mg	96	D1030
4 mm	6 mm	11 mg	100	D1035
4 mm	6 mm	11 mg	10 x 96	D1110
5 mm	8 mm	19 mg	96	D1031
5 mm	8 mm	19 mg	100	D1036
5 mm	8 mm	19 mg	96 x 10	D1111

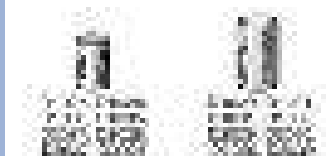

Actual size

Ultra-Clean Pressed Silver Capsules

Diameter	Height	Weight	Pack	Cat no
4 mm	6 mm	22 mg	96	D2027
4 mm	6 mm	22 mg	250	D2028
5 mm	8 mm	31 mg	96	D2029
5 mm	8 mm	31 mg	250	D2030

Ultra-Clean Pressed Aluminium Capsules

Diameter	Height	Weight	Pack	Cat no
4 mm	6 mm	22 mg	96	D3027
4 mm	6 mm	22 mg	250	D3028
5 mm	8 mm	31 mg	96	D3029
5 mm	8 mm	31 mg	250	D3030

Ultra-Clean Pressed Nickel Capsules

Diameter	Height	Weight	Pack	Cat no
5 mm	8 mm	38 mg	96	D3504

Actual size

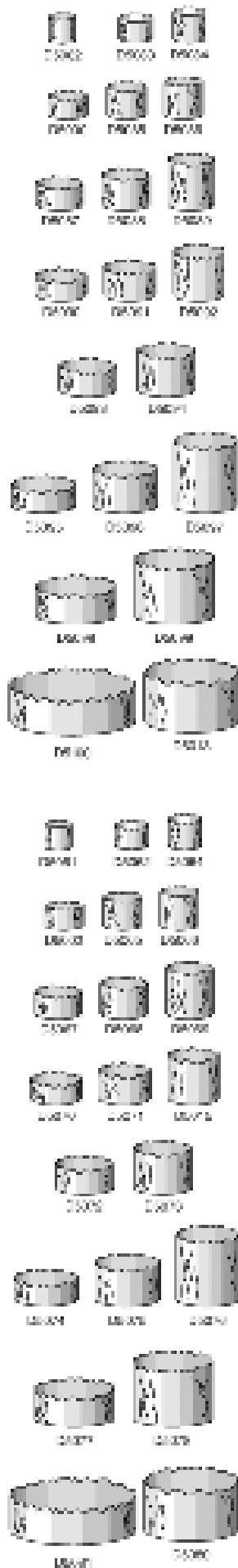

Pressed Aluminium Pans for Solid Samples

Diameter	Height	Weight	Pack	Cat no
4 mm	3.5 mm	4 mg	100	D5082
5 mm	3 mm	4 mg	100	D5083
5 mm	4.25 mm	6 mg	100	D5084
6 mm	2.5 mm	4 mg	100	D5000
6 mm	3.75 mm	8 mg	100	D5085
6 mm	5 mm	8 mg	100	D5086
7 mm	3.25 mm	6 mg	100	D5087
7 mm	4.5 mm	8 mg	100	D5088
7 mm	7 mm	14 mg	100	D5089
8 mm	2.75 mm	6 mg	100	D5090
8 mm	4 mm	8 mg	100	D5091
8 mm	5.5 mm	55 mg	100	D8601
8 mm	6.5 mm	14 mg	100	D5092
9 mm	3.5 mm	8 mg	100	D5093
9 mm	6 mm	14 mg	100	D5094
10 mm	3 mm	8 mg	100	D5095
10 mm	5.5 mm	14 mg	100	D5096
10 mm	10 mm	28 mg	100	D5097
12.5 mm	4.25 mm	14 mg	100	D5098
12.5 mm	8.75 mm	28 mg	100	D5099
15 mm	3 mm	14 mg	100	D5012
15 mm	7.5 mm	28 mg	100	D5013
20 mm	5 mm	28 mg	100	D5100

Elemental Microanalysis pressed pans for solid samples are manufactured to exacting standards to ensure consistently low blank values, high quality fabrication and uniform weight. They are available in aluminium, silver and tin.

They can be used without any cleaning pre-treatment, but for critical samples solvent cleaning or the use of our ultra-clean capsules is recommended. They should not be ultrasonically cleaned as damage may result.

We can manufacture pans in sizes and materials other than those listed below. We also offer discounts for larger quantities. Please enquire for details.

Pressed Aluminium Pan D8601
(Not actual size)



Pressed Silver Pans for Solid Samples

Silver pans may become slightly oxidised or tarnished due to oxygen and contaminants in the air. This can easily be removed by heating to 375°C in air for one hour prior to use.

Silver pans should be stored long term under an inert gas.

Diameter	Height	Weight	Pack	Cat no
4 mm	3.5 mm	15 mg	100	D5061
5 mm	3 mm	15 mg	100	D5062
5 mm	4.25 mm	22 mg	100	D5064
6 mm	2.5 mm	15 mg	100	D5002
6 mm	3.75 mm	22 mg	100	D5065
6 mm	5 mm	31 mg	100	D5066
7 mm	3.25 mm	22 mg	100	D5067
7 mm	4.5 mm	31 mg	100	D5068
7 mm	7 mm	54 mg	100	D5069
8 mm	2.75 mm	22 mg	100	D5070
8 mm	4 mm	31 mg	100	D5071
8 mm	6.5 mm	54 mg	100	D5015
9 mm	3.5 mm	31 mg	100	D5072
9 mm	6 mm	54 mg	100	D5073
10 mm	3 mm	31 mg	100	D5074
10 mm	5.5 mm	54 mg	100	D5075
10 mm	10 mm	110mg	100	D5076
12.5 mm	4.25 mm	54 mg	100	D5077
12.5 mm	8.75 mm	110 mg	100	D5078
15 mm	7.5 mm	110 mg	100	D5080
20 mm	5 mm	110 mg	100	D5081

Pressed Tin Pans for Solid Samples

Elemental Microanalysis pressed pans for solid samples are available in two weights - solid and ultra-light.

They can be used without any cleaning pre-treatment, but for critical samples solvent cleaning or the use of our ultra-clean capsules is recommended.

They should not be ultrasonically cleaned as damage may result.

Standard weight

Diameter	Height	Weight	Pack	Cat no
4 mm	3.5 mm	8 mg	100	D5040
5 mm	3 mm	8 mg	100	D5041
5 mm	4.25 mm	12 mg	100	D5042
6 mm	2.5 mm	8 mg	100	D5003
6 mm	3.75 mm	12 mg	100	D5043
6 mm	5 mm	17 mg	100	D5044
7 mm	3.25 mm	12 mg	100	D5045
7 mm	4.5 mm	17 mg	100	D5046
7 mm	7 mm	30 mg	100	D5047
8 mm	2.75 mm	12 mg	100	D5048
8 mm	4 mm	17 mg	100	D5049
8 mm	6.5 mm	30 mg	100	D5050
9 mm	3.5 mm	17 mg	100	D5051
9 mm	6 mm	30 mg	100	D5052
10 mm	3 mm	17 mg	100	D5053
10 mm	5.5 mm	30 mg	100	D5054
10 mm	10 mm	62 mg	100	D5055
12.5 mm	4.25 mm	30 mg	100	D5056
12.5 mm	8.75 mm	62 mg	100	D5057
15 mm	7.5 mm	62 mg	100	D5059
20 mm	5 mm	62 mg	100	D5060

Ultra-light weight

Weigh approximately 40% less than the standard range.

Diameter	Height	Weight	Pack	Cat no
4 mm	3.5 mm	5 mg	100	D5200
5 mm	3 mm	5 mg	100	D5201
5 mm	4.25 mm	8 mg	100	D5202
6 mm	2.5 mm	5 mg	100	D5203
6 mm	3.75 mm	8 mg	100	D5204
6 mm	5 mm	11 mg	100	D5205
7 mm	3.25 mm	8 mg	100	D5206
7 mm	4.5 mm	11 mg	100	D5207
7 mm	7 mm	19 mg	100	D5208
8 mm	2.75 mm	8 mg	100	D5209
8 mm	4 mm	11 mg	100	D5210
8 mm	6.5 mm	19 mg	100	D5211
9 mm	3.5 mm	11 mg	100	D5212
9 mm	6 mm	19 mg	100	D5213
10 mm	3 mm	11 mg	100	D5214
10 mm	5.5 mm	19 mg	100	D5215
10 mm	10 mm	39 mg	100	D5216
12.5 mm	4.25 mm	19 mg	100	D5217
12.5 mm	8.75 mm	39 mg	100	D5218
15 mm	7.5 mm	39 mg	100	D5220
20 mm	5 mm	39 mg	100	D5221

Ultra-clean, ultra-light weight

Weigh approximately 40% less than the standard range.

Diameter	Height	Weight	Pack	Cat no
4 mm	3.5 mm	8 mg	100	D5222

Actual size

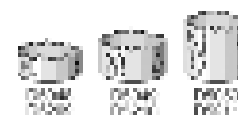

Pressed Weighing Pans for solid samples

Aluminium Pans for moisture determination

CHNOS analysis

Elemental Microanalysis moisture determination pans are suitable for use with all models of moisture determination balance. They are constructed with ribbing for rigidity whilst still maintaining low tare weight.

Diameter	Depth	Weight	Pack	Cat no
100 mm	7 mm	2.4 g	100	D5014



Aluminium Pans D5014

Nickel Boat Liners

CHNOS analysis

Length	Width	Height	Weight	Pack	Cat no
50 mm	15 mm	8 mm	0.200 mg	100	D5300
66 mm	21 mm	11 mm	1.31 g	10	D5310



Nickel Boat Liners D5310

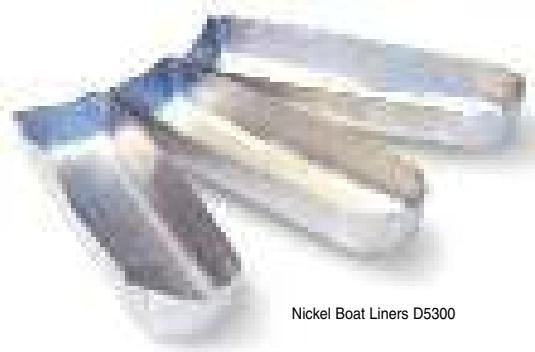

Nickel Boat Liners D5300

Tin Foil Evaporating Cups

CHNOS analysis

Tin Foil Evaporating Cup
D8012 / D8013



Ideal for drying liquid samples down to residues prior to feeding into an elemental analyser. The shape has been designed so that the residue forms in the bottom of the cup and allows easy folding. Capacity is approximately 10 cc.

Diameter	Height	Weight	Pack	Cat no
24 mm	28 mm	390 mg	48	D8012

Pre-Cleaned Foil Cups

Diameter	Height	Weight	Pack	Cat no
24mm	28mm	390 mg	48	D8013

A thermostatically controlled hotplate with a 40-position plate machined to hold the cups in position for drying is available.

Product	Unit	Cat no
Hotplate for tin foil evaporating cups, 220/240 V ac	1	E5006
Hotplate for tin foil evaporating cups, 110/120 V ac	1	E5007

Foil Discs for Glass Fibre Filters, Fibrous and Sticky Samples

Elemental Microanalysis metal foil discs are ideal for the encapsulation of sticky, fibrous or other samples which are difficult to handle using conventional pressed capsules. A small dab or a few fibres on a disc is easily encapsulated by folding the foil around the sample. With a little practice even glass fibre filters can be rolled up in foil discs to form neat cylinders which fit the instrument carousel.

Standard weight tin foil discs

Standard weight tin foil discs

Manufactured from high purity tin. Suitable for routine use.

Diameter	Thickness	Weight	Pack	Cat no
11 mm	0.0125 mm	8mg	100	D1060
13.5 mm	0.0125 mm	12mg	100	D1061
16 mm	0.0125 mm	17mg	100	D1063
21 mm	0.0125 mm	30mg	100	D1064
30 mm	0.0125 mm	62mg	100	D1066
34 mm	0.0125 mm	82mg	100	D1059
85 mm	0.0125 mm	510mg	100	D1077

Ultra-light weight tin foil discs

Weigh approximately 40% less than the standard range. These lower weight squares produce less swarf build-up in combustion tubes, have lower blank values and provide more available oxygen for the effective combustion of the sample.

Diameter	Thickness	Weight	Pack	Cat no
11 mm	0.008 mm	5mg	100	D1070
13.5 mm	0.008 mm	8mg	100	D1071
16 mm	0.008 mm	11mg	100	D1073
21 mm	0.008 mm	19mg	100	D1074
30 mm	0.008 mm	39mg	100	D1076

Heavy weight tin foil discs

Diameter	Thickness	Weight	Pack	Cat no
30 mm	0.200 mm	0.1g	100	D1065

Silver foil discs

Manufactured from high purity silver foil. Suitable for routine use.

Diameter	Thickness	Weight	Pack	Cat no
11 mm	0.015 mm	15mg	100	D2060
13.5 mm	0.015 mm	22mg	100	D2061
16 mm	0.015 mm	31mg	100	D2063
21 mm	0.015 mm	54mg	100	D2064
30 mm	0.015 mm	110mg	100	D2066

Aluminium foil discs

Manufactured from high purity aluminium foil. Suitable for routine use.

Diameter	Thickness	Weight	Pack	Cat no
11 mm	0.015 mm	4mg	100	D3060
13.5 mm	0.015 mm	6mg	100	D3061
16 mm	0.015 mm	8mg	100	D3063
21 mm	0.015 mm	14mg	100	D3064
30 mm	0.015 mm	28mg	100	D3066

Foil discs in other materials

Elemental Microanalysis foil discs are available in other materials and sizes for your specific application. Please enquire for more information.

Tin Foil Cones

Weight	Pack	Cat no
120mg	100	D9001
120mg	1500	D9010

(All outlines actual sizes)

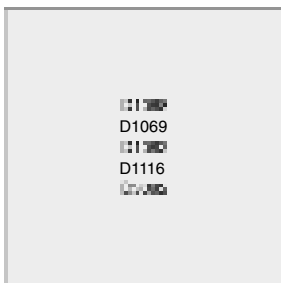
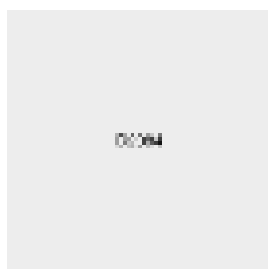
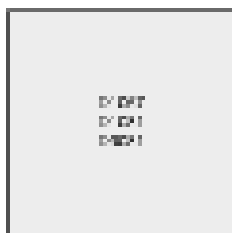
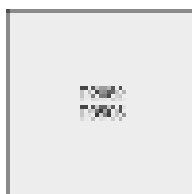

Foil Squares for Glass Fibre Filters, Fibrous and Sticky Samples

Standard weight tin foil squares

Manufactured from high quality tin. Suitable for routine use.

Size	Thickness	Weight	Pack	Cat no
22 x 22 mm	0.0125 mm	44 mg	100	D1062
30 x 30 mm	0.0125 mm	82 mg	100	D1067
37 x 37 mm	0.0125 mm	125 mg	100	D1068
37 x 37 mm	0.0125 mm	125 mg	400	D1116
43 x 43 mm	0.0125 mm	168 mg	100	D1085
50 x 50 mm	0.0125 mm	225 mg	100	D1115

Ultra-light weight tin foil squares

Weigh approximately 40% less than the standard range. These lower weight squares produce less swarf build-up in combustion tubes, have lower blank values and provide more available oxygen for the effective combustion of the sample.

Size	Thickness	Weight	Pack	Cat no
22 x 22 mm	0.008 mm	28 mg	100	D1080
30 x 30 mm	0.008 mm	52 mg	100	D1081
37 x 37 mm	0.008 mm	80 mg	100	D1082

Silver foil squares

Manufactured from high purity silver. Suitable for routine use.

Size	Thickness	Weight	Pack	Cat no
15 x 15 mm	0.015 mm	35mg	100	D2080
20 x 20 mm	0.015 mm	63mg	100	D2081
25 x 25 mm	0.015 mm	98mg	100	D2082
35 x 35 mm	0.015 mm	192mg	100	D2084

Aluminium foil squares

Manufactured from high purity aluminium. Suitable for routine use.

Size	Thickness	Weight	Pack	Cat no
22 x 22 mm	0.015 mm	19mg	100	D3080
30 x 30 mm	0.015 mm	36mg	100	D3081
37 x 37 mm	0.015 mm	55mg	100	D3082

Nickel foil squares

Suitable for routine use. Annealed.

Size	Thickness	Weight	Pack	Cat no
25 x 25 mm	0.015 mm	83mg	100	D3505

Foil squares in other materials

Elemental Microanalysis foil squares are available in other materials and sizes for your specific application. Please enquire for more information.

Elemental Microanalysis metal foil squares are ideal for the encapsulation of sticky, fibrous or other samples which are difficult to handle using conventional pressed capsules. A small dab or a few fibres on a square is easily encapsulated by folding the foil around the sample. With a little practice even glass fibre filters can be rolled up in foil squares to form neat cylinders which fit the instrument carousel.



Flat Bottom Smooth Tin Capsules

Diameter	Height	Weight	Pack	Cat no
2 mm	3.5 mm	19 mg	100	D4040
2 mm	4 mm	21 mg	100	D4041
2 mm	4.5 mm	23 mg	100	D4019
2 mm	5 mm	25 mg	100	D4042
2 mm	5.5 mm	27 mg	100	D4000
3 mm	3.5 mm	31 mg	100	D4025
3 mm	4 mm	34 mg	100	D4043
3 mm	4.5 mm	38 mg	100	D4044
3 mm	5 mm	41 mg	100	D4045
3 mm	5.5 mm	45 mg	100	D4046
3 mm	6 mm	48 mg	100	D4001
3 mm	7 mm	54 mg	100	D4020
3 mm	8 mm	65 mg	100	D4021
3.5 mm	4 mm	42 mg	100	D4032
3.5 mm	4.5 mm	46 mg	100	D4047
3.5 mm	5 mm	51 mg	100	D4048
3.5 mm	5.5 mm	55 mg	100	D4033
3.5 mm	6 mm	59 mg	100	D4049
3.5 mm	7 mm	66 mg	100	D4034
3.5 mm	8 mm	75 mg	100	D4050
3.5 mm	9 mm	84 mg	100	D4035
5 mm	5 mm	76 mg	100	D4051
5 mm	5.5 mm	82 mg	100	D4052
5 mm	6 mm	88 mg	100	D4054
5 mm	7 mm	98 mg	100	D4036
5 mm	8 mm	111 mg	100	D4057
5 mm	9 mm	122 mg	100	D4059
5 mm	10 mm	134 mg	100	D4037
5 mm	12 mm	157 mg	100	D4038
5 mm	18 mm	222 mg	100	D4039
6 mm	6 mm	153 mg	100	D4084
6 mm	7 mm	172 mg	100	D4085
6 mm	8 mm	191 mg	100	D4086
6 mm	9 mm	210 mg	100	D4087
6 mm	10 mm	229 mg	100	D4088
6 mm	12 mm	266 mg	100	D4089
6 mm	18 mm	290 mg	100	D4090
8 mm	8 mm	219 mg	100	D4091
8 mm	9 mm	237 mg	100	D4092
8 mm	10 mm	255 mg	100	D4093
8 mm	12 mm	292 mg	100	D4094
8 mm	18 mm	401 mg	100	D4095
8 mm	20 mm	438 mg	100	D4096

Elemental Microanalysis smooth wall capsules for liquid samples are extruded to exacting standards to ensure consistently low blank values, high quality fabrication and low weight. Smooth wall capsules can be used without any cleaning pre-treatment, but we recommend solvent cleaning for critical work.

The capsules can be sealed using a proprietary sealing tool or mole grips, available from our microanalytical sundries section.

We can manufacture capsules in sizes and materials other than those listed here. Please enquire for details.

2 mm flat bottom capsules



Actual size

3 mm flat bottom capsules



3.5 mm flat bottom capsules



5 mm flat bottom capsules



6 mm flat bottom capsules



8 mm flat bottom capsules



Elemental Microanalysis smooth wall capsules for liquid samples are extruded to exacting standards to ensure consistently low blank values, high quality fabrication and low weight. Smooth wall capsules can be used without any cleaning pre-treatment, but we recommend solvent cleaning for critical work.

The capsules can be sealed using a proprietary sealing tool or mole grips, available from our microanalytical sundries section.

We can manufacture capsules in sizes and materials other than those listed below. Please enquire for details.

5 mm round bottom capsules

Actual size



6 mm round bottom capsules



8 mm round bottom capsules



6 mm part round bottom capsules



8 mm part round bottom capsules

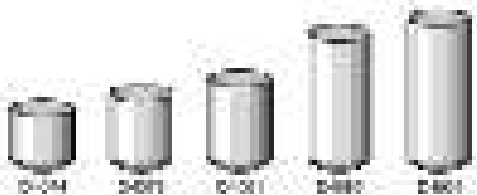

Round Bottom Smooth Tin Capsules

Diameter	Height	Weight	Pack	Cat no
3.5 mm	7 mm	70 mg	100	D4002
3.5 mm	5.5 mm	55 mg	100	D4023
5 mm	5 mm	96 mg	100	D4010
5 mm	8 mm	130 mg	100	D4058
5 mm	10 mm	153 mg	100	D4061
5 mm	12 mm	176 mg	100	D4062
5 mm	18 mm	245 mg	100	D4003
6 mm	6 mm	126 mg	100	D4008
6 mm	8 mm	153 mg	100	D4066
6 mm	10 mm	181 mg	100	D4070
6 mm	12 mm	208 mg	100	D4072
6 mm	18 mm	290 mg	100	D4007
8 mm	8 mm	224 mg	100	D4011
8 mm	10 mm	260 mg	100	D4078
8 mm	12 mm	297 mg	100	D4080
8 mm	18 mm	406 mg	100	D4082
8 mm	20 mm	443 mg	100	D4009

Part Round Bottom Smooth Tin Capsules

Diameter	Height	Weight	Pack	Cat no
6 mm	6 mm	122 mg	100	D4063
6 mm	8 mm	149 mg	100	D4067
6 mm	10 mm	177 mg	100	D4071
6 mm	12 mm	204 mg	100	D4073
6 mm	18 mm	287 mg	100	D4030
6 mm	18 mm	290 mg	1000	D4015
8 mm	8 mm	244 mg	100	D4074
8 mm	10 mm	281 mg	100	D4079
8 mm	12 mm	317 mg	100	D4081
8 mm	18 mm	427 mg	100	D4083
8 mm	20 mm	465 mg	100	D4031

Part Round Bottom Smooth Copper Capsules

Diameter	Height	Weight	Pack	Cat no
6 mm	18 mm	197 mg	100	D4100

Round Bottom Smooth Aluminium Capsules

Diameter	Height	Weight	Pack	Cat no
3 mm	7 mm	-	100	D3010
3.2 mm	7 mm	-	250	D4111
3.5 mm	9 mm	-	250	D4110

Round Bottom Smooth Nickel Capsules

Diameter	Height	Weight	Pack	Cat no
5 mm	11 mm	270 mg	100	D3506

Round Bottom Smooth Silver Capsules

Diameter	Height	Weight	Pack	Cat no
2 mm	5 mm	-	250	D4103
3.5 mm	4 mm	90 mg	250	D4104
3.5 mm	5.5 mm	113 mg	250	D4102
3.5 mm	9 mm	137 mg	100	D4101



Platinum Boat D5004



Platinum Weighing Boats

Length	Width	Height	Thickness	Weight	Pack	Cat no
9 mm	4 mm	2.5 mm + tab	0.1 mm	150 mg	1	D5004
9 mm	4 mm	2.5 mm + tab	0.05 mm	75 mg	1	D5005
12 mm	4 mm	2.7 mm	0.1 mm	198 mg	1	D5110
12 mm	4 mm	2.7 mm	0.05 mm	99 mg	1	D5115

Actual size



Nickel Boats D5006



Nickel Weighing Boats

Length	Width	Height	Thickness	Weight	Pack	Cat no
9 mm	4 mm	2.5 mm + tab	0.15 mm	92 mg	100	D5006
12 mm	4 mm	2.7 mm	0.15 mm	122 mg	100	D5111
12 mm	4 mm	4 mm	0.13 mm	-	100	D5122
12 mm	6 mm	6 mm	0.13 mm	-	100	D5123

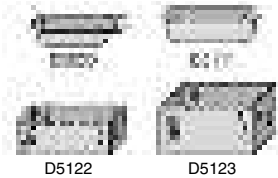

Aluminium Weighing Boats

Length	Width	Height	Thickness	Weight	Pack	Cat no
9 mm	4 mm	2.5 mm + tab	0.1 mm	18 mg	100	D5007
12 mm	6 mm	6 mm	0.015 mm	25 mg	500	D5132
12 mm	4 mm	2.7 mm	0.1 mm	25 mg	100	D5010
12 mm	4 mm	2.7 mm	0.1 mm	25 mg	500	D5016
12 mm	4 mm	4 mm	0.015 mm	18 mg	100	D5030
12 mm	4 mm	4 mm	0.015 mm	18 mg	1000	D5131
12 mm	6 mm	6 mm	0.015 mm	25 mg	100	D5031
15 mm	8 mm	8 mm	0.015 mm	100 mg	250	D5036
20 mm	10 mm	9 mm	0.015 mm	175 mg	120	D5037

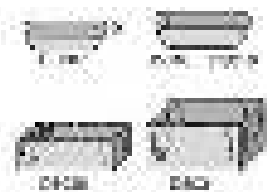

Tin Boat D5023



Tin Weighing Boats

Length	Width	Height	Thickness	Weight	Pack	Cat no
9 mm	4 mm	2.5 mm + tab	0.1 mm	40 mg	100	D5009
12 mm	4 mm	2.7 mm	0.1 mm	64 mg	100	D5113
12 mm	4 mm	4 mm	0.0125 mm	21 mg	100	D5022
12 mm	4 mm	4 mm	0.0125 mm	21 mg	1000	D5130
12 mm	6 mm	6 mm	0.0125 mm	38 mg	100	D5023
12 mm	6 mm	6 mm	0.0125 mm	38 mg	500	D5131
15 mm	8 mm	8 mm	0.0200 mm	100 mg	250	D5032
20 mm	10 mm	9 mm	0.200 mm	175 mg	120	D5033

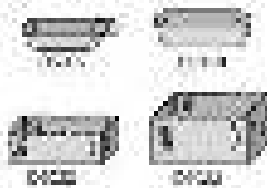

Tin Boat D5032

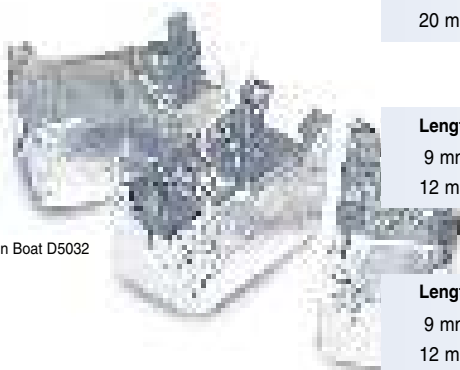

Copper Weighing Boats

Length	Width	Height	Thickness	Weight	Pack	Cat no
9 mm	4 mm	2.5 mm + tab	0.1 mm	109 mg	100	D5114
12 mm	4 mm	2.7 mm	0.1 mm	83 mg	100	D5020



Silver Weighing Boats

Length	Width	Height	Thickness	Weight	Pack	Cat no
9 mm	4 mm	2.5 mm + tab	0.015 mm	19 mg	100	D5008
12 mm	4 mm	2.7 mm	0.015 mm	15 mg	100	D5112
12 mm	4 mm	4 mm	0.015 mm	36 mg	100	D5024
12 mm	6 mm	6 mm	0.015 mm	66 mg	100	D5026



Sample Encapsulation

Product	Pack	Cat no
Filter paper roll, 30 mm x 100 m, for paper flags	1	E2014
Gelatin capsules, size 4	100	E2021
Gelatin capsules, 5.5 x 17 mm	100	E2141
Gelatin capsules, 6 x 19 mm	100	E2142
Cellulose capsules	400	D9004



Cellulose Capsules D9004



Organic standards from Elemental Microanalysis are traceable to the National Institute of Standards and Technology (N.I.S.T.) Maryland USA, and/or (where appropriate) other accredited certification organisations. These materials are suitable for use as working standards for elemental analysis and are supplied with batch Certificates of Analysis.

Cat No	Standard	Pack	%C	%H	%N	%O	%S	%Cl%	%Br%	%I%	%F%	%P
B2012	1,3-Dinitrobenzene §	1g	42.87	2.40	16.66	38.07						
B2103	1,3-Dinitrobenzene §	5g	42.87	2.40	16.66	38.07						
B2010	1-Chloro-2,4-dinitrobenzene §	1g	35.58	1.49	13.83	31.60		(17.50)				
iB2044	2,5-(Bis(5-tert-butyl-2-benzo-oxazol-2-yl) thiophene (BBOT)	1g	72.52	6.09	6.51	7.43	7.44					
B2046	2,5-(Bis(5-tert-butyl-2-benzo-oxazol-2-yl) thiophene (BBOT)	5g	72.52	6.09	6.51	7.43	7.44					
B2021	2-Iodobenzoic Acid	1g	33.90	2.03		(12.90)				(51.17)		
B2034	3,5-Dinitrobenzoic Acid	1g	39.64	1.90	13.20	45.25						
B2118	3,5-Dinitrobenzoic Acid	5g	39.64	1.90	13.20	45.25						
B2008	4-Bromobenzoic Acid	1g	41.82	2.51		(15.92)			(39.75)			
B2143	4-Bromobenzoic Acid	5g	41.82	2.51		(15.92)			(39.75)			
B2009	4-Chlorobenzoic Acid	1g	53.70	3.22		20.44		(22.64)				
B2117	4-Chlorobenzoic Acid	5g	53.70	3.22		20.44		(22.64)				
B2013	4-Fluorobenzoic Acid	1g	60.01	3.59		(22.84)					(13.56)	
B2015	4-Nitroaniline §	1g	52.17	4.38	20.29	23.16						
B2020	8-Hydroxyquinoline	1g	74.47	4.86	9.65	11.02						
B2000	Acetanilide	1g	71.09	6.71	10.36	11.84						
B2114	Acetanilide	5g	71.09	6.71	10.36	11.84						
B2001	Alanine	1g	40.44	7.92	15.92	35.92						
B2003	Anthracene	1g	94.34	5.66								
B2042	Aspartic Acid	1g	36.09	5.30	10.52	48.08						
B2002	Atropine §	1g	70.56	8.01	4.84	16.59						
B2006	Atropine §	10g	70.56	8.01	4.84	16.59						
B2004	Benzoic Acid	1g	68.85	4.95		26.20						
B2047	Benzoic Acid	5g	68.85	4.95		26.20						
B2007	Benzylthiuronium Chloride §	1g	47.40	5.47	13.82		15.82	(17.49)				
B2108	Benzylthiuronium Chloride §	5g	47.40	5.47	13.82		15.82	(17.49)				
B2030	Caffeine	1g	49.48	5.19	28.85	16.48						
B2104	Caffeine	5g	49.48	5.19	28.85	16.48						
B2250	Calcium Carbonate	50g	12.00									
B2300	Coal Standard	50g					0.30					
B2301	Coal Standard	50g					0.50					
B2302	Coal Standard	50g					0.70					
B2303	Coal Standard	50g					0.85					
B2304	Coal Standard	50g					1.00					
B2305	Coal Standard	50g					1.50					
B2306	Coal Standard	50g					2.00					
B2307	Coal Standard	50g					2.50					
B2308	Coal Standard	50g					3.00					
B2309	Coal Standard	50g					3.50					
B2310	Coal Standard	50g					4.00					
B2311	Coal Standard	50g					5.00					
B2312	Coal Standard	50g					6.00					
B2315	Coke Standard	50g					0.70					
B2316	Coke Standard	50g					0.90					
B2317	Coke Standard	50g					0.50					
B2005	Cyclohexanone2,4dinitrophenylhydrazone (CYC)	1g	51.79	5.07	20.14	23.00						
B2035	Cystine	1g	29.99	5.03	11.66	26.63	26.69					
B2105	Cystine	5g	29.99	5.03	11.66	26.63	26.69					
B2011	Dibenzyldisulphide	1g	68.25	5.73			26.02					
B2039	Diphenyl §	1g	93.46	6.54								
B2033	Ethylenediaminetetra-acetic Acid (EDTA)	1g	41.09	5.52	9.59	43.79						
B2120	Ethylenediaminetetra-acetic Acid (EDTA)	25g	41.09	5.52	9.59	43.79						

Values in brackets are not certified values and are provided for information purposes only.

§ Denotes substance that is classified as a dangerous for shipping purposes. An additional charge for shipping may apply, please contact us for details.

Cat No	Standard	Pack	%C	%H	%N	%O	%S	%Cl%	%Br%	%I%	%F%	%P
B2336	Extreme Pressure Oil	118ml					2.00					
B2337	Extreme Pressure Oil	118ml					3.00					
B2338	Extreme Pressure Oil	118ml					4.00					
B2019	Hexachlorobenzene §	1g	23.30					(74.70)				
B2330	High Sulphur Residual Oil	118ml					30.00					
B2331	High Sulphur Residual Oil	118ml					20.00					
B2332	High Sulphur Residual Oil	118ml					10.00					
B2333	High Sulphur Residual Oil	118ml					6.00					
B2334	High Sulphur Residual Oil	118ml					5.00					
B2040	Imidazol §	1g	52.93	5.92	41.15							
B2041	Isatin	1g	65.30	3.43	9.52	21.75						
B2145	Lubricant Standard	2g	72.36	11.44	0.90		3.06					
B2045	Methionine	1g	40.25	7.43	9.39	21.44	21.49					
B2014	Naphthalene §	1g	93.71	6.29								
B2132	Nicotinamide	1g	59.01	4.95	22.94	13.10						
B2016	Phenacetin	1g	67.01	7.31	7.82	17.86						
B2113	Phenanthrene Enriched	1g			0.50		0.60					
B2360	Residual Oil Standard	118ml					0.10					
B2361	Residual Oil Standard	118ml					0.20					
B2362	Residual Oil Standard	118ml					0.30					
B2363	Residual Oil Standard	118ml					0.40					
B2364	Residual Oil Standard	118ml					0.50					
B2365	Residual Oil Standard	118ml					0.60					
B2366	Residual Oil Standard	118ml					0.70					
B2367	Residual Oil Standard	118ml					0.80					
B2368	Residual Oil Standard	118ml					0.90					
B2369	Residual Oil Standard	118ml					1.00					
B2370	Residual Oil Standard	118ml					1.50					
B2371	Residual Oil Standard	118ml					2.00					
B2372	Residual Oil Standard	118ml					2.50					
B2373	Residual Oil Standard	118ml					3.00					
B2374	Residual Oil Standard	118ml					3.50					
B2375	Residual Oil Standard	118ml					4.00					
B2376	Residual Oil Standard	118ml					4.50					
B2031	Stearic Acid	1g	76.00	12.75		11.25						
B2102	Stearic Acid	5g	76.00	12.75		11.25						
B2032	Sucrose	1g	42.10	6.48		51.41						
B2121	Sucrose	25g	42.10	6.48		51.41						
B2037	Sulphamethazine	1g	51.78	5.07	20.12	11.49	11.52					
B2106	Sulphamethazine	5g	51.78	5.07	20.12	11.49	11.52					
B2017	Sulphamic Acid §	1g		3.11	14.43	49.44	33.02					
B2036	Sulphanilamide	1g	41.85	4.68	16.26	18.58	18.62					
B2043	Sulphanilic Acid	1g	41.61	4.07	8.09	27.71	18.51					
B2147	Sulphanilic Acid	5g	41.61	4.07	8.09	27.71	18.51					
B2018	Trifluoroacetanilide	1g	50.80	3.20	7.41	(8.46)				(30.13)		
B2022	Triphenylphosphine	1g	82.42	5.76								(11.81)
B2038	Urea	1g	20.00	6.71	46.64	26.64						

Values in brackets are not certified values and are provided for information purposes only.

§ Denotes substance that is classified as a dangerous for shipping purposes. An additional charge for shipping may apply, please contact us for details.

Values quoted for Natural Standards are indicative and may vary from batch to batch.

Natural Standards

Cat No	Standard	Pack	%C	%H	%N	%O	%S	%Cl%	%Br%	%I%	%F%	%P
B2273	Alfalfa	30g	45.77	5.42	3.37		0.20					
B2276	Oatmeal	30g	47.76	5.72	2.09		0.16					
B2141	Orchard Leaves	20g	44-52	5.7-6.5	2-2.8							
B2277	Barley	30g	46.68	5.57	1.50		0.14					
B2272	Corn Gluten	30g	50.29	6.33	10.95		0.96					
B2270	Corn Meal	30g	45.35	5.44	1.91		0.15					
B2154	Protein (Casein) Standard	30g	47.02		13.63		0.86					
B2278	Rice Flour	30g	44.70	5.88	1.36		0.12					
B2275	Rye Flour	30g	44.25	5.78	1.86		0.17					
B2150	Sediment Standard (High Organic Content)	30g	6.72		0.50		0.92					
B2152	Soil Standard (Low Organic Content)	30g	1.65		0.14		0.031					
B2158	Sorghum Flour Standard	30g	41.58		1.46		0.105					
B2271	Soy Bean Meal	30g	45.18	5.69	7.98		0.37					
B2156	Wheat Flour Standard	30g	39.53		1.47		0.098					
B2160	Chitin	30g	45.07	6.71	6.88	37.27						
B2162	Algae (Spirulina)	30g	46.60	6.90	10.34		0.92					
B2164	Algae (Bladderwrack)	30g	33.86	4.87	1.27		2.31					
B2166	Birch Leaf	30g	48.33	6.36	2.09		0.16					
B2168	Coconut Shell Powder	30g	48.11	6.14	0.12							
B2170	Olive Stone Powder	30g	47.46	6.26	0.18							

Combustion Catalysts and Reagents

Product	Pack	Cat no
Aluminium Oxide (Alumina), granular, 0.2 - 0.5 mm, isotope grade	10g	B1129
Aluminium Oxide (Alumina), granular, 0.2 - 0.85 mm	25g	B1128
Aluminium Oxide (Alumina), granular, 0.85 - 1.7 mm	50g	B1127
Aluminium Oxide (Alumina), granular, 1.7 - 3.35 mm, replaces B1060	100g	B1126
Aluminium Oxide (Alumina), hollow spheres, 2 - 4 mm	40g	B1090
Aluminium Oxide (Alumina) pellets	200g	B1163
Cerium Oxide, granular, 0.85 - 1.7 mm	25g	B1028
Cerium Oxide, granular, 0.85 - 1.7 mm	100g	B1219
Chromium Oxide, granular, 0.85 - 1.7 mm	25g	B1004
Chromium Oxide, granular, 0.85 - 1.7 mm	50g	B1179
Chromium Oxide, granular, 0.85 - 1.7 mm	100g	B1099
Chromium Oxide, granular	500g	B1200
Chromium Oxide on Alumina, granular, 0.85 - 1.7 mm	50g	B1131
Chromium Oxide on Alumina, granular, 0.85 - 1.7 mm	100g	B1132
Cobaltous/ic Oxide, granular	25g	B1001
Cobaltous/ic Oxide, granular	100g	B1121
Cobaltous/ic Oxide Silvered, granular	500g	B1201
Combustion catalyst, NA2000, mixed catalyst	40g	B1103
Copper Oxide, coarse wires, 0.65 x 6mm	100g	B1219
Copper Oxide, fine wires, 0.5 x 4mm	50g	B1002
Copper Oxide, fine wires, 0.5 x 4 mm	100g	B1125
Copper Oxide, fine wires, 0.5 x 4mm	250g	B1122
Copper Oxide, fine wires, isotope grade, 0.5 x 4 mm	50g	B1080
Copper Oxide, granular, 0.1 - 0.5 mm	50g	B1003
Copper Oxide, granular, 0.1 - 0.5 mm	500g	B1160
Copper Oxide, isotope grade, granular, 0.1 - 0.5 mm	50g	B1051
Nickel Oxide, granular, 0.2 - 0.5 mm, isotope grade	25g	B1130
Nickel Oxide, granular, 0.85 - 1.7 mm	25g	B1034
Nickel Oxide/Chromium Oxide, granular, 0.85 - 1.7 mm	25g	B1033
Nickel Oxide/Chromium Oxide, granular, 0.85 - 1.7 mm	100g	B1146
Platinised Alumina, 10% Pt, granular, 0.2 - 0.5 mm	2g	B1096
Platinised Alumina, 20% Pt, granular, 0.2 - 0.5 mm	2g	B1097
Platinised Alumina, 1% Pt, granular, 0.85 - 1.2 mm	50g	B1139
Platinised Alumina pellets, 0.5% Pt, 'nitrogen catalyst'	50g	B1061
Platinised Copper Oxide, 10% Pt, granular, 0.2 - 0.5 mm	2g	B1030
Platinised Copper Oxide, 20% Pt, granular, 0.2 - 0.5 mm	2g	B1050
Rare Earth Copper Oxide, granular, 0.85 - 1.7 mm	50g	B1123
Silver Tungstate/Magnesium Oxide, granular, 0.85 - 1.7 mm	25g	B1038
Silver Tungstate/Magnesium Oxide, granular, 0.85 - 1.7 mm	100g	B1036
Silver Tungstate/Magnesium Oxide on Chromosorb A, granular	25g	B1058
Silver Tungstate/Magnesium Oxide on Chromosorb A, granular	100g	B1402
Silvered Cobaltous/ic Oxide, granular, 0.85 - 1.7 mm	25g	B1000
Silvered Cobaltous/ic Oxide, granular, 0.85 - 1.7 mm	100g	B1120
Silvered Copper Oxide, fine wires, 0.5 x 4 mm	50g	B1070
Silvered Copper Oxide, granular, 0.1 - 0.5 mm	50g	B1071
Tungstic Oxide, granular, 0.85 - 1.7 mm	25g	B1025
Tungstic Oxide, granular, 0.85 - 1.7 mm	100g	B1152
Tungstic Oxide on Alumina, granular, 0.85 - 1.7 mm	25g	B1031
Tungstic Oxide on Alumina, granular, 0.85 - 1.7 mm	100g	B1133
Tungstic Oxide/Zirconium Oxide, granular, 0.85 - 1.7 mm	50g	B1082

High purity materials tested for quality and performance. Reagents are volume stable at elevated temperatures and are virtually free from dusting and caking. These products can be manufactured in other mesh sizes as required to suit your application.

§ Denotes hazardous material.

Tungstic Oxide, Granular
B1025



Silver Tungstate on Magnesium Oxide
B1036

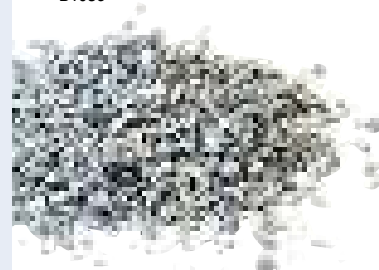

Copper Oxide Wires
B1122

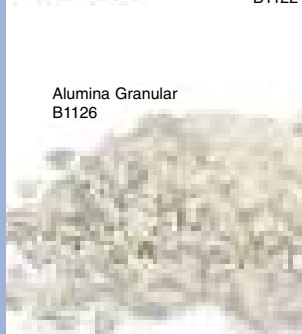

Alumina Granular
B1126



Rare Earth Copper Oxide, Granular
B1123



Chromium Oxide Granular
B1179



Cobaltous/ic Oxide
B1001

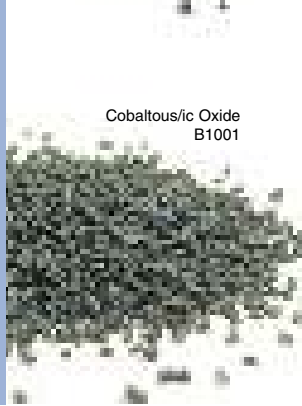

Platinum Catalysts

Product	Pack	Cat no
Platinised Alumina, 10% Pt, granular, 0.2 - 0.5 mm	2g	B1096
Platinised Alumina, 20% Pt, granular, 0.2 - 0.5 mm	2g	B1097
Platinised Alumina, 1% Pt, granular, 0.85 - 1.2 mm	50g	B1139
Platinised Alumina pellets, 0.5% Pt, 'nitrogen catalyst'	50g	B1061
Platinised Carbon, granular, 10% Pt, 0.2 - 0.85 mm	5g	B1005
Platinised Carbon, granular, 10% Pt, 0.85 - 1.7 mm	5g	B1134
Platinised Carbon, granular, 20% Pt, 0.2 - 0.85 mm	5g	B1095
Platinised Carbon, granular, 20% Pt, 0.85 - 1.7 mm	5g	B1135
Platinised Copper Oxide, 10% Pt, granular, 0.2 - 0.5 mm	2g	B1030
Platinised Copper Oxide, 20% Pt, granular, 0.2 - 0.5 mm	2g	B1050
Platinum gauze strip, 12 x 150 mm	1	D7006
Platinum gauze catalyst strip, 20 x 200 mm, 325 mg	1	D7014
Platinum wire	1m	D9100

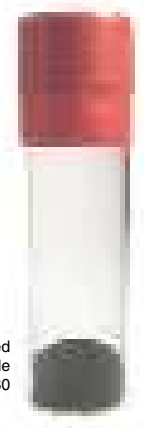

Platinised
Copper Oxide
B1030

Nickel Catalysts

Product	Pack	Cat no
Nickel wool, fine wire	2g	B1007
Nickelised Carbon, 10% Ni, granular, 0.3 - 0.85 mm	5g	B1085
Nickelised Carbon, 20% Ni, granular, 0.3 - 0.85 mm	5g	B1006
Nickelised Carbon, 30% Ni, granular, 0.3 - 0.85 mm	5g	B1086
Nickelised Carbon, 40% Ni, granular, 0.3 - 0.85 mm	5g	B1087
Nickelised Carbon, 50% Ni, granular, 0.3 - 0.85 mm	5g	B1181
Nickelised Carbon, 10% Ni, granular, 0.85 - 1.7 mm	5g	B1104
Nickelised Carbon, 20% Ni, granular, 0.85 - 1.7 mm	5g	B1105
Nickelised Carbon, 30% Ni, granular, 0.85 - 1.7 mm	5g	B1088
Nickelised Carbon, 40% Ni, granular, 0.85 - 1.7 mm	5g	B1106
Nickelised Carbon, 50% Ni, granular, 0.85 - 1.7 mm	5g	B1182
Nickel Carbon wool	5g	B1242

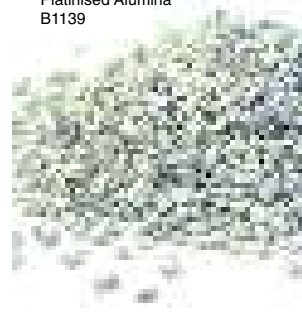

Platinised Alumina
B1139



Nickelised
Carbon
B1181



Nickel Wool
B1007



Platinised Alumina Pellets
B1061



Copper Turnings B1136



Copper Granules B1084

Copper Wires, Fine B1015



Nickel Oxide Granular B1130

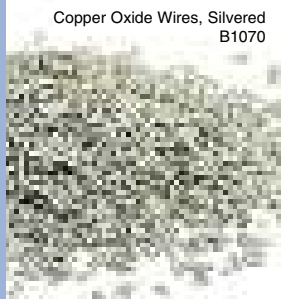

Copper Oxide Wires, Silvered B1070

Copper Reduction Reagents

Product	Pack	Cat no
Copper granules, 0.1 - 0.5 mm	100g	B1013
Copper granules, 0.1 - 0.5 mm, pound pack	454g	B1084
Copper granules, 0.1 - 0.5 mm	500g	B1175
Copper granules, fine, 0.05 - 0.2 mm	100g	B1108
Copper granules, 0.3 - 0.85 mm	100g	B1137
Copper granules, 0.3 - 0.85 mm, pound pack	454g	B1138
Copper granules, silvered, 0.1 - 0.5 mm	100g	B1011
Copper granules, silvered, 0.1 - 0.5 mm, 5 x 10g ampoules	50g	B1012
Copper turnings, fine long strands	100g	B1062
Copper turnings, fine long strands	200g	B1107
Copper turnings, extra fine long strands	100g	B1136
Copper wires, coarse, 0.65 x 6 mm	50g	B1046
Copper wires, coarse, 0.65 x 6 mm	100g	B1016
Copper wires, coarse, 0.65 x 6 mm, 3 x 100g	300g	B1213
Copper wires, coarse, 0.65 x 6 mm	454g	B1199
Copper wires, coarse, 0.65 x 6mm, highest purity for CHNS	40g	B1040
Copper wires, fine, 0.5 x 4 mm	100g	B1015
Copper wires, fine, 0.5 x 4 mm, 3 x 100g	300g	B1091
Copper wires, fine, 0.5 x 4 mm, pound pack	454g	B1083
Copper wires, fine, 0.5 x 4 mm	500g	B1176
Copper wires, fine, 0.5 x 4 mm, highest purity, for CHNS	40g	B1035
Copper wires, fine, 0.5 x 4 mm, highest purity, for CHNS	100g	B1177
Copper wires, fine, 0.5 x 4 mm, highest purity, for CHNS	454g	B1178

Our copper reagents are hermetically sealed in ampoules to ensure high quality and a long shelf life. Elemental Microanalysis copper reagents have a very high oxygen capacity and are thermally treated to prevent expansion when converted to CuO.

The high purity prevents tailing caused by absorption and desorption of gases caused by impurities in the copper (especially important in the analysis of sulphur). Carbon content (organic contaminants such as oil) is zero.

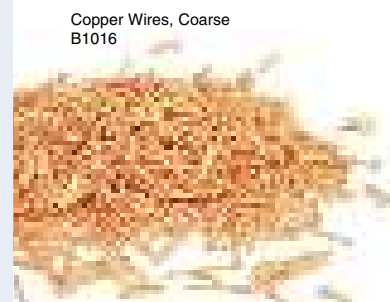

Copper Wires, Coarse B1016

Reagents for Isotope Analysis

Product	Pack	Cat no
Carbon, high purity, granular, 0.2 - 0.5 mm	1g	B1065
Chrome catalyst	100g	B1450
Copper Oxide, fine wires, isotope grade, 0.5 x 4 mm	50g	B1080
Copper Oxide, isotope grade, granular, 0.1 - 0.5 mm	50g	B1051
Copper wire, 0.1 mm	12 x 300mm	B1156
Nickel Oxide, granular, 0.2 - 0.5 mm, isotope grade	25g	B1130
Platinised Copper Oxide, 10% Pt, granular, isotope grade, 0.2 - 0.5 mm	2g	B1030
Platinised Copper Oxide, 20% Pt, granular, isotope grade, 0.2 - 0.5 mm	2g	B1050
Platinised Alumina, 10% Pt, granular, isotope grade, 0.2 - 0.5 mm	2g	B1096
Platinised Alumina, 20% Pt, granular, isotope grade, 0.2 - 0.5 mm	2g	B1097
Platinised Carbon, 10% Pt, granular, isotope grade, 0.2 - 0.85 mm	5g	B1005
Platinised Carbon, 20% Pt, granular, isotope grade, 0.2 - 0.85 mm	5g	B1095
1% Platinum/1% Nickel Oxide on copper oxide granules, 0.2 - 0.5 mm	5g	B1158
3% Platinum/1% Nickel Oxide on copper oxide granules, 0.2 - 0.5 mm	5g	B1159
1% Platinum/1% Nickel Oxide on copper oxide wires, isotope catalyst	5g	B1149
3% Platinum/1% Nickel Oxide on copper oxide wires, isotope catalyst	5g	B1151
Quartz (silica) chips, turnings, isotope grade, 0.2 - 0.5 mm	50g	B1027
Silvered Copper Oxide, fine wires, isotope grade, 0.5 x 4 mm	50g	B1070
Silvered Copper Oxide, granular, isotope grade, 0.1 - 0.5 mm	50g	B1071

The Elemental Microanalysis range is suitable for use in isotope analysers. However, due to the demanding nature of isotope work we have developed a range of products with a higher specification especially for isotope analysis.

Silica (Quartz) Chips B1027



Interference Removal Reagents

Product	Pack	Cat no
Copper granules, silvered, 0.1 - 0.5 mm	100g	B1011
Copper granules, silvered, 0.1 - 0.5 mm, 5 x 10g ampoules	50g	B1012
Iron chips	100g	B1063
Iron wool, very fine	25g	B1157
Lead(II) Chromate, granular, 0.85 - 1.7 mm §	50g	B1029
Lead(II) Chromate, granular, 0.85 - 1.7 mm §	250g	B1207
Manganese Dioxide	10g	B1204
Silver gauze, (welded in 4 places) 610mm x 76mm	1	B1026
Silver gauze fine, 60 mesh (linear inch), 150 x 150 mm	1	B1023
Silver gauze, fine, 60 mesh, 12.5 x 150 mm	1	B1037
Silver Oxide/Silver Tungstate on Chromosorb P, 30 - 60 mesh	25g	B1055
Silver Tungstate/Magnesium Oxide, granular, 0.85 - 1.7 mm	100g	B1036
Silver Vanadate reagent, granular, 0.85 - 1.7 mm	10g	B1009
Silver Vanadate reagent, granular, 0.85 - 1.7 mm	100g	B1142
Silver Vanadate reagent on Chromosorb A, granular	10g	B1059
Silver wool, very fine wire, reeled	10g	B1010
Silver wool, very fine wire, unreeled	10g	B1119
Silver wool, 0.05mm fine wire, unreeled	50g	B1231
Silvered Cobaltous/ic Oxide, granular, 0.85 - 1.7 mm	25g	B1000
Universal fluorine reagent	25g	B1112
Universal fluorine reagent	100g	B1113

Copper Granules,
Silvered B1011

Lead Chromate B1029

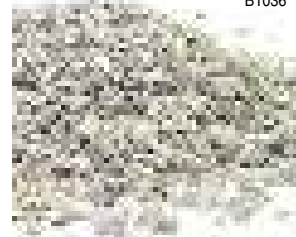
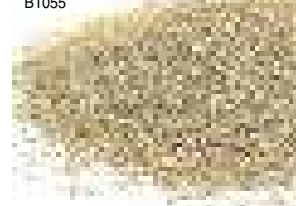
Silver Tungstate/Magnesium Oxide
B1036Silver Oxide/Silver Tungstate
on Chromosorb P
B1055Silver Vanadate on
Chromosorb A
B1059

Iron Chips B1063

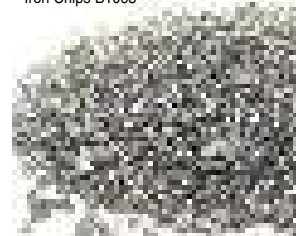
Manganese Dioxide
B1204

Pyrolysis Catalysts and Reagents

Product	Pack	Cat no
Carbon, high purity, granular, 0.3 - 0.85 mm	5g	B1043
Carbon, high purity, granular, 0.2 - 0.5 mm	1g	B1065
Carbon, high purity, granular, 0.85 - 1.7 mm	5g	B1111
Chrome catalyst	100g	B1450
Nickel wool, fine wire	2g	B1007
Nickel Carbon wool	5g	B1242
Nickelised Carbon, 10% Ni, granular, 0.3 - 0.85 mm	5g	B1085
Nickelised Carbon, 20% Ni, granular, 0.3 - 0.85 mm	5g	B1006
Nickelised Carbon, 30% Ni, granular, 0.3 - 0.85 mm	5g	B1086
Nickelised Carbon, 40% Ni, granular, 0.3 - 0.85 mm	5g	B1087
Nickelised Carbon, 50% Ni, granular, 0.3 - 0.85 mm	5g	B1181
Nickelised Carbon, 10% Ni, granular, 0.85 - 1.7 mm	5g	B1104
Nickelised Carbon, 20% Ni, granular, 0.85 - 1.7 mm	5g	B1105
Nickelised Carbon, 30% Ni, granular, 0.85 - 1.7 mm	5g	B1088
Nickelised Carbon, 40% Ni, granular, 0.85 - 1.7 mm	5g	B1106
Nickelised Carbon, 50% Ni, granular, 0.85 - 1.7 mm	5g	B1182
Platinised Carbon, granular, 10% Pt, isotope grade, 0.2 - 0.85 mm	5g	B1005
Platinised Carbon, granular, 20% Pt, isotope grade, 0.2 - 0.85 mm	5g	B1095
Platinum gauze catalyst strip, 12 x 150 mm, 260 mg	1	D7006
Platinum gauze catalyst strip, 20 x 200 mm, 325 mg	1	D7014
Quartz (silica) chips, turnings, 0.2 - 0.5 mm	50g	B1027
Quartz (silica) chips, turnings, 0.85 - 1.7 mm	50g	B1008
Quartz (silica) chips, turnings, 1 - 2 mm	100g	B1214
Quartz (silica) chips, turnings, 2 - 3 mm	250g	B1109
Quartz (silica) chips, turnings, 2 - 4 mm	50g	B1215
Quartz (silica) chips, turnings, 2 - 4 mm	250g	B1110

Copper Granules,
Silvered B1012Nickelised Carbon
B1106Nickel Carbon Wool
B1242

Copper Sulphate B1022



Lead Oxide B1039



Silver Oxide/Silver Tungstate on Chromosorb B1055

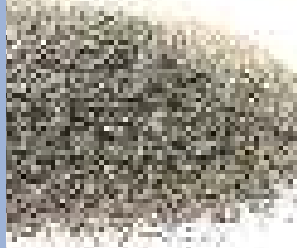

Vanadium Pentoxide B4001



Magnesium Oxide B4012



Miscellaneous Materials

Product	Pack	Cat no
Absorbent discs, 3.5 mm	100	E2105
Quartz wool discs, 15 mm	25	B1250
Quartz wool discs, 16.5 mm	25	B1251
Quartz wool discs, 22 mm	25	B1252
Aluminium Oxide wool, fine	20g	B1089
Cotton wool, pure	100g	B1045
Glass wool, fine	50g	B1056
Glass wool, fine	227g	B1167
Glass wool, fine	454g	B1166
Glass wool, fine	500g	B1124
Nickel sheet lining, 0.15 x 130 x 130 mm	1	B1024
Nickel sheet lining, 0.15 x 130 x 260 mm	1	B1048
Nickel wool, fine wire	2g	B1007
Platinum sheet, 0.05 x 50 x 50 mm	1	D7012
Platinum sheet, 0.1 x 50 x 50 mm	1	D7013
Platinum wire	1m	D9100
Quartz (silica) chips, turnings, 0.2 - 0.5 mm	50g	B1027
Quartz (silica) chips, turnings, 0.85 - 1.7 mm	50g	B1008
Quartz (silica) chips, turnings, 1 - 2 mm	100g	B1214
Quartz (silica) chips, turnings, 2 - 3 mm	250g	B1109
Quartz (silica) chips, turnings, 2 - 4 mm	50g	B1215
Quartz (silica) chips, turnings, 2 - 4 mm	250g	B1110
Quartz (silica) wool, very pure, very fine	5g	B1017
Quartz (silica) wool, very pure, very fine	10g	B1208
Quartz (silica) wool, very pure, very fine	50g	B1102
Zirconium Oxide (zirconia) cloth, 70 x 609 mm	1	E2051

Quartz (Silica) Chips B1110

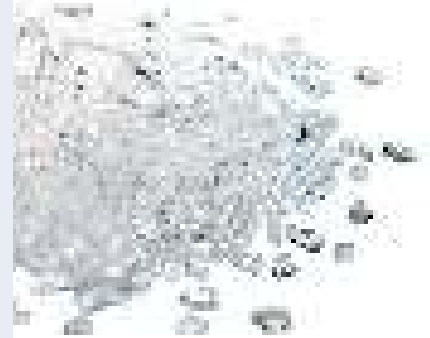

Absorbent Discs E2105



Combustion Aids

Product	Pack	Cat no
Carbon, high purity, powder	5g	B4009
Carbon, high purity, powder	15g	B4008
Cobalt Oxide, additive, fine powder	10g	B4005
Copper Oxide, additive, fine powder	10g	B4003
Lead Oxide, red, additive, fine powder §	1g	B1039
Magnesium Oxide, fine powder	10g	B4012
Silver Oxide, additive, fine powder	1g	B4006
Silver Oxide/Silver Tungstate on Chromosorb P, 30 - 60 mesh	25g	B1055
Sucrose sample additive	50g	B4011
Tin, additive, fine powder	10g	B4002
Tungstic Oxide, additive, fine powder	10g	B4000
Tungstic Oxide, additive, fine powder	25g	B4013
Tungstic Oxide, additive, fine powder	90g	B4014
Universal combustion additive, fine powder	1g	B4007
Vanadium Pentoxide, additive, fine powder §	1g	B4010
Vanadium Pentoxide, additive, fine powder §	10g	B4001

Nickel Wool B1007



Gas Doping Reagents

Product	Pack	Cat no
Chloropentane, halogen doping §	10ml	B4004
Copper Sulphate, granular, suitable for water doping	50g	B1022
Copper Sulphate, granular, suitable for water doping	250g	B1114

Column Packings

Product	Pack	Cat no
Molecular sieve 5A, 50 - 80 mesh	100g	B3004
Molecular sieve 5A, 80 - 100 mesh	100g	B3000
Molecular sieve 5A, 100 - 120 mesh	100g	B3005
Porapak QS, 50 - 80 mesh	75ml	B3002
Porapak QS, 80 - 100 mesh	75ml	B3001
Porapak QS, 100 - 120 mesh	75ml	B3003

Chromosorb W
B3016

Absorbent Materials

Product	Pack	Cat no
Absorbent discs, 3.5 mm	100	E2105
Chromosorb P, acid washed, 30 - 60 mesh	10g	B3010
Chromosorb P, acid washed, 45 - 60 mesh	10g	B3011
Chromosorb P, acid washed, 60 - 80 mesh	10g	B3012
Chromosorb P, acid washed, 80 - 100 mesh	10g	B3013
Chromosorb P, acid washed, 100 - 120 mesh	10g	B3014
Chromosorb W, acid washed, 30 - 60 mesh	10g	B3015
Chromosorb W, acid washed, 30 - 60 mesh	25g	B3017
Chromosorb W, acid washed, 30 - 60 mesh	100g	B3018
Chromosorb W, acid washed, 80 - 100 mesh	10g	B3016

Molecular Sieve B1047

Magnesium
Perchlorate
B1101

Scrubbing & Purification Reagents

Product	Pack	Cat no
Carbosorb, granular, 0.7 - 1.2 mm, CO2 absorbent, (14 - 22 mesh) §	25g	B1018
Carbosorb, granular, 0.7 - 1.2 mm, CO2 absorbent, (14 - 22 mesh) §	100g	B1236
Carbosorb, granular, 0.7 - 1.2 mm, CO2 absorbent, (14 - 22 mesh) §	200g	B1100
Carbosorb, granular, 0.8 - 1.4 mm, CO2 absorbent, (12 - 20 mesh) §	25g	B1042
Carbosorb, granular, 0.8 - 1.4 mm, CO2 absorbent, (12 - 20 mesh) §	200g	B1168
Carbosorb, granular, 1.4 - 2.8 mm, CO2 absorbent, (6 - 12 mesh) §	25g	B1041
Carbosorb, granular, 1.4 - 2.8 mm, CO2 absorbent, (6 - 12 mesh) §	100g	B1237
Carbosorb, granular, 1.4 - 2.8 mm, CO2 absorbent, (6 - 12 mesh) §	200g	B1180
EMADrone, granular, 14 - 25 mesh, H2O absorbent §	454g	B1161
EMAsorb A, granular, 0.8 - 1.6 mm, CO2 absorbent §	25g	B1116
EMAsorb A, granular, 0.8 - 1.6 mm, CO2 absorbent §	200g	B1115
EMAsorb A, granular, 0.8 - 1.6 mm, CO2 absorbent §	500g	B1162
EMAsorb B, granular, 1.6 - 3 mm, CO2 absorbent §	25g	B1118
EMAsorb B, granular, 1.6 - 3 mm, CO2 absorbent §	200g	B1117
EMAsorb B, granular, 1.6 - 3 mm, CO2 absorbent §	454g	B1164
Magnesium Perchlorate, granular, H2O absorbent §	25g	B1019
Magnesium Perchlorate, granular, H2O absorbent §	100g	B1101
Magnesium Perchlorate, granular, H2O absorbent §	500g	B1081
Magnesium Perchlorate, granular, H2O absorbent, self indicating §	25g	B1140
Magnesium Perchlorate, granular, H2O absorbent, self indicating §	100g	B1141
Molecular sieve 3A, pellets	25g	B1021
Molecular sieve 3A, pellets	100g	B1047
Molecular sieve 3A, pellets	250g	B1143
Molecular sieve 4A, pellets	25g	B1020
Sicapent	2.8l	B1197
Silica gel, drying agent, indicating, 0.78 - 2.8 mm	100g	B1044
Silica gel	1kg	B1066
Soda lime, granular, CO2 absorbent §	100g	B1211
Soda lime, granular, CO2 absorbent §	200g	B1189
Soda lime, granular, CO2 absorbent §	800g	B1092

§ Denotes Hazardous substance

Soda Lime Granular B1189



EMADrone B1161



CE/Thermo Finnigan 1108/1110/1500(2)/2500

Description	Pack	OEM	Cat no.
Water Scrubber Tube, threaded	1	23101008	C1008
CO ₂ Scrubber Tube, threaded	1	28113090	C1014
Water/CO ₂ Scrubber Tube	1	28113060	E2040
Crucible for C1072 & C1078, pack of 5	1		C1016
Reaction/Reduction Tube, transparent	1	46820020	C1022
Reaction/Reduction Tube, translucent	1	46820000	C1023
Reaction/Reduction Tube, transparent	1		C1024
Reaction/Reduction Tube, translucent	1		C1025
Crucible for C1023, C1025 pack of 5	1		C1016
Sleeve Insert 235mm (closed one end)	1		C1051
Sleeve Insert 220mm (closed one end)	1		C1052
Removable Crucible, for use with C1022 & C1024, pack of 5	1		C1053
Reaction Tube, modified, translucent/transparent	1		C1055
Reaction Tube, modified, transparent	1		C1056
Reaction Tube, low volume	1		C1057

Description	Pack	OEM	Cat no.
Reaction Tube, transparent, for sulphur (utilising E2171 Teflon kit)	1		C1060
Reaction Tube Quick 'n' Easy system	1		C1066
Filter Tube Straight Quick 'n' Easy System	1		C1068
Reaction Tube Quick 'n' Easy system (Heavy Wall)	1		C1072
Reaction Tube (Heavy Wall)	1	46820001	C1078
Sleeve Insert 205mm (open both ends)	1		C1090
Sleeve Insert 205mm (closed one end)	1		C1091
Sleeve Insert 235mm (open both ends)	1		C1093
Sleeve Insert 220mm (open both ends)	1		C1096
Filter Tube Quick 'n' Easy 11 to 11mm	1		C4004
Filter Tube Quick 'n' Easy 11 to 22mm	1		C4037
Stainless Steel Reaction Tube	1	46820050	E2159
Metal Crucible	1	25205000	D6005

Metal Swarf Crucible
D6005



Swarf Crucibles
C1016



Water/Carbon Dioxide Scrubber
E2040

- C1023
- E2159
- C1072
- C1066
- C1025
- C1055
- C1056
- C1024
- C1057
- C1078
- C1060
- C1022

Pre-packed tubes for this instrument are available - please see configuration guide for details.

400mm

300mm

200mm

100mm

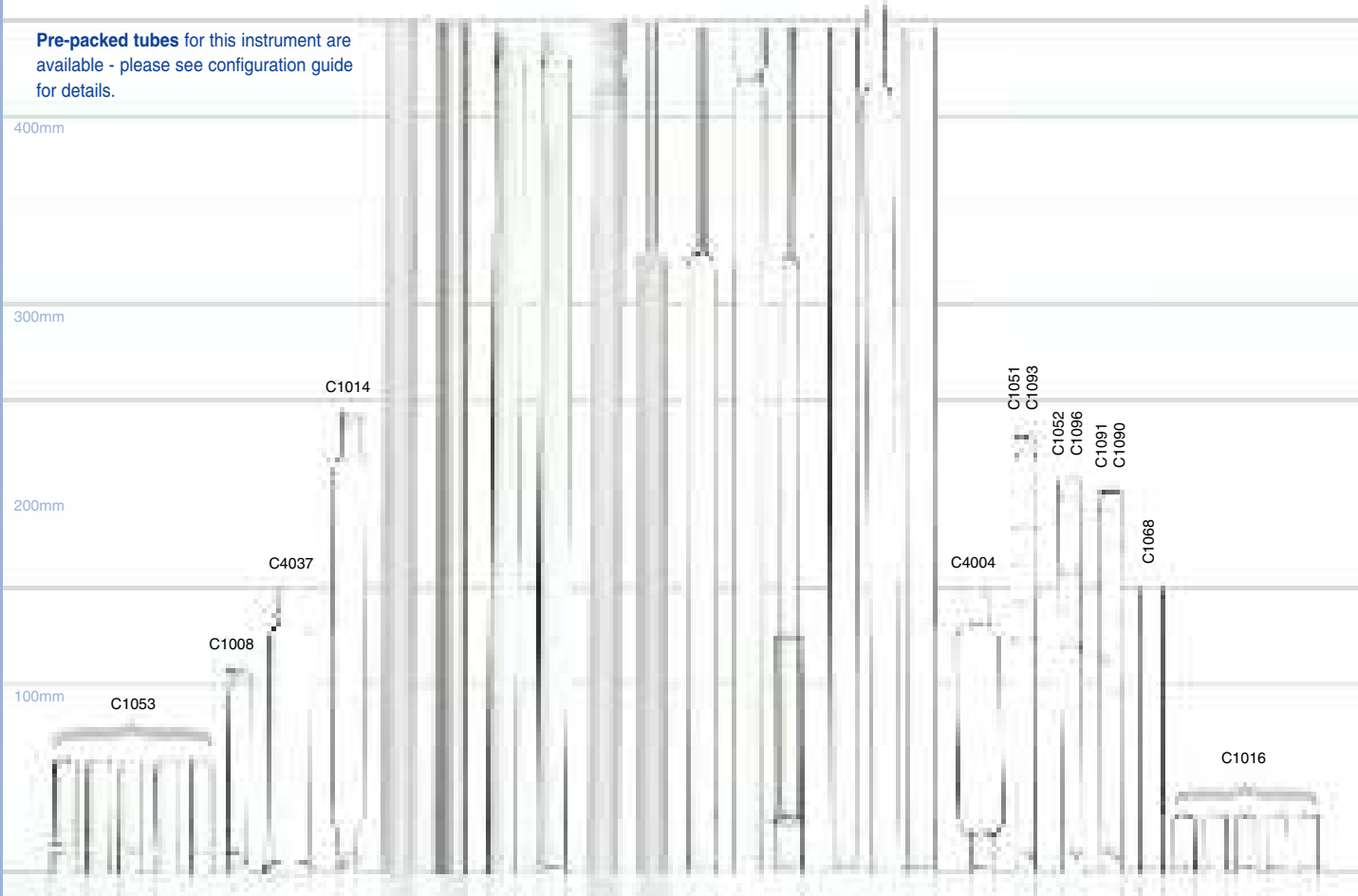

C1014

C4037

C1008

C1053

C1051
C1093

C1052

C1096

C1091

C1090

C4004

C1068

C1016

Carlo Erba/ThermoFinnigan Flash EA™ 1112

Description	Pack	OEM	Cat no.
Water Scrubber Tube, threaded	1	23101008	C1008
CO ₂ Scrubber Tube, threaded	1	28113090	C1014
Crucible Pack of 5	1		C1016
Sleeve insert 235mm (Closed one end)	1		C1051
Sleeve insert 220mm (Closed one end)	1		C1052
Reaction Tube	1	46820070	C1069
Sleeve insert 205mm (Open both ends)	1		C1090
Sleeve insert 205mm (Closed one end)	1		C1091
Sleeve insert 235mm (Open both ends)	1		C1093
Sleeve insert 220mm (Open both ends)	1		C1096
Water/CO ₂ Scrubber Tube	1	28113060	E2040
Trap large (GL32 style)	1	28113106	E2047

C1069

Pre-packed tubes for this instrument are available - please see configuration guide for details.

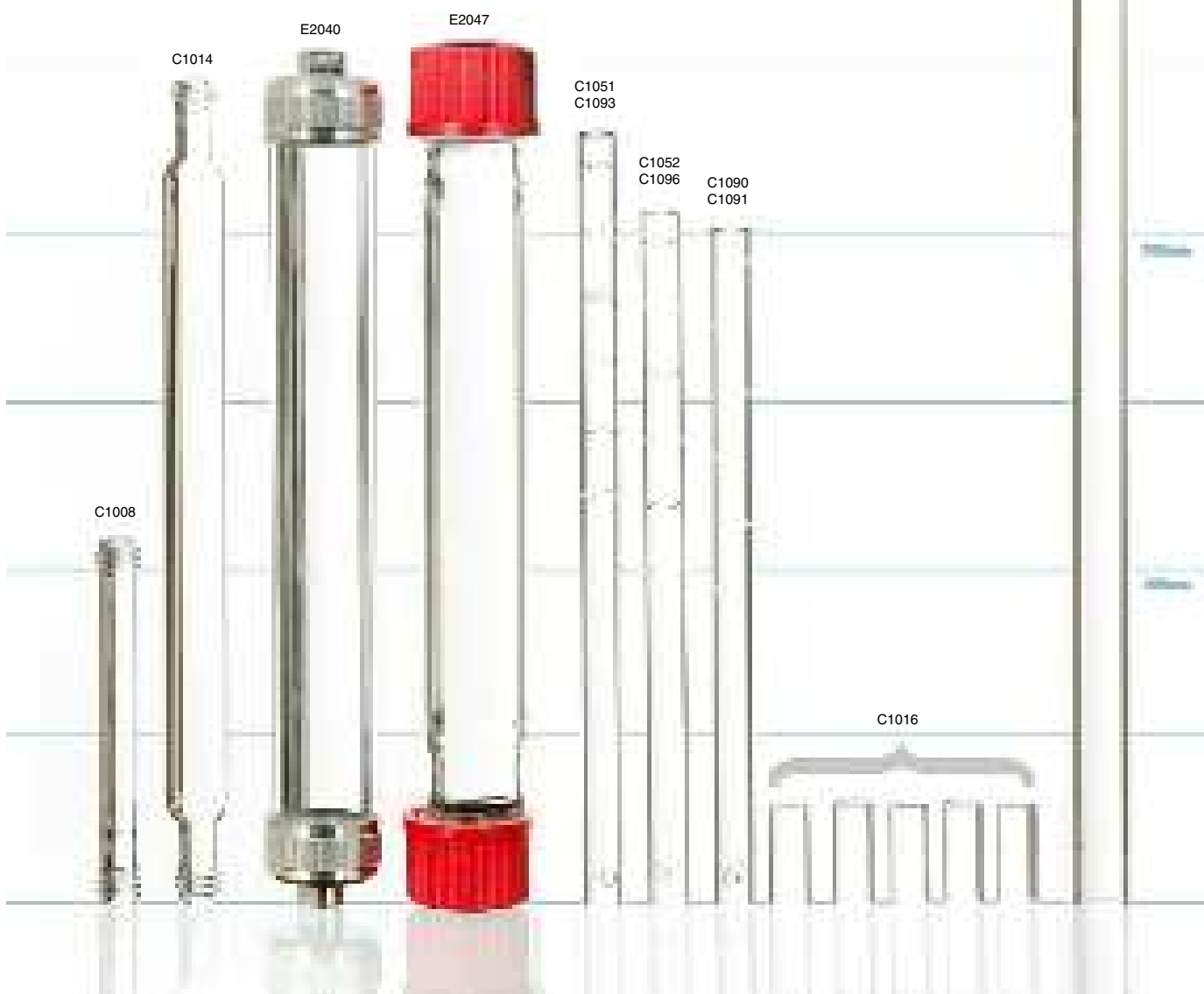

Carlo Erba/ThermoFinnigan 1500 Series 1

Description	Pack	OEM	Cat no.
Reaction/Reduction Tube, transparent	1	46801600	C1002
Water Scrubber Tube, threaded	1	23101008	C1008
Reaction/Reduction Tube, translucent	1	46801700	C1012
CO ₂ Scrubber Tube, threaded	1	28113090	C1014
Sleeve insert 180mm (Open both ends)	1		C1050
Reaction tube Quick n' Easy system	1		C1066
Filter Tube Straight Quick n Easy System	1		C1068
Reaction tube Quick n' Easy system (Heavy Wall)	1		C1072
Sleeve insert 220mm (Open both ends)	1		C1094
Sleeve insert 220mm (Closed one end)	1		C2030
Filter Tube Quick n Easy 11 to 11mm	1		C4004
Filter Tube Quick n Easy 11 to 22mm	1		C4037

Pre-packed tubes for this instrument are available - please see configuration guide for details.

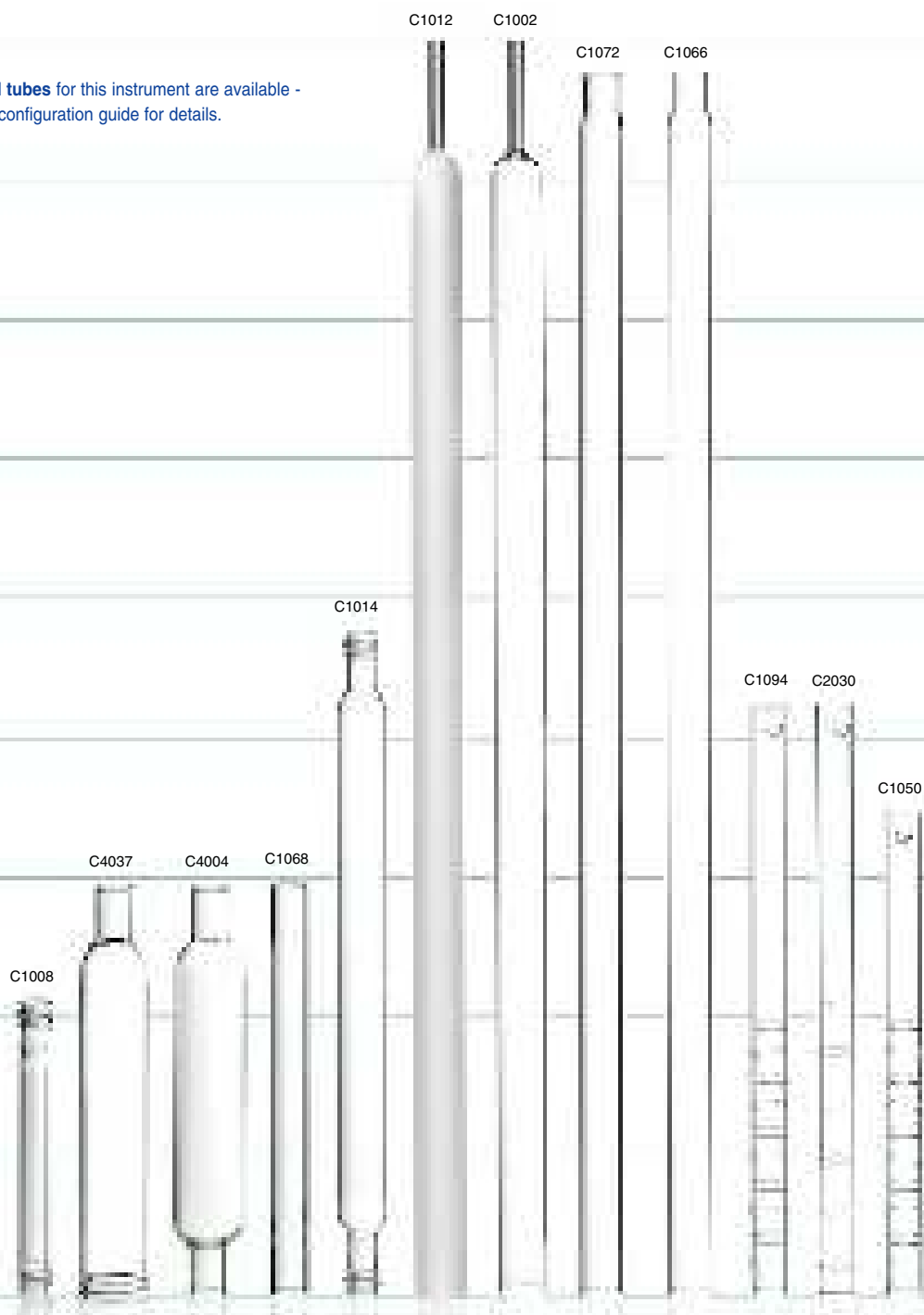

CE/Thermo Finnigan 1106

Costech

Description	Pack	OEM	Cat no.
Combustion Tube	1	46800900	C1000
Reduction Tube Quartz	1	46801000	C1003
Reduction Tube Stainless Steel	1	39103800	E2020
Swarf Crucible	1	25204500	C1004
Swarf Crucible	1	25204400	C1005
Water Scrubber Tube, threaded	1	28113100	C1008
Halogens Trap	1	28104400	C1021

Description	Pack	OEM	Cat no.
Water Scrubber Tube, threaded	1		C1008
CO ₂ Scrubber Tube, threaded	1		C1014
Reaction/Reduction Tube, transparent	1	61104	C1022
Reaction/Reduction Tube, translucent	1		C1023
Sleeve insert 220mm (Closed one end)	1		C1052
Sleeve insert 205mm (Open both ends)	1		C1090
Sleeve insert 205mm (Closed one end)	1		C1091
Sleeve insert 220mm (Open both ends)	1		C1096

Pre-packed tubes for this instrument are available - please see configuration guide for details.

Pre-packed tubes for this instrument are available - please see configuration guide for details.

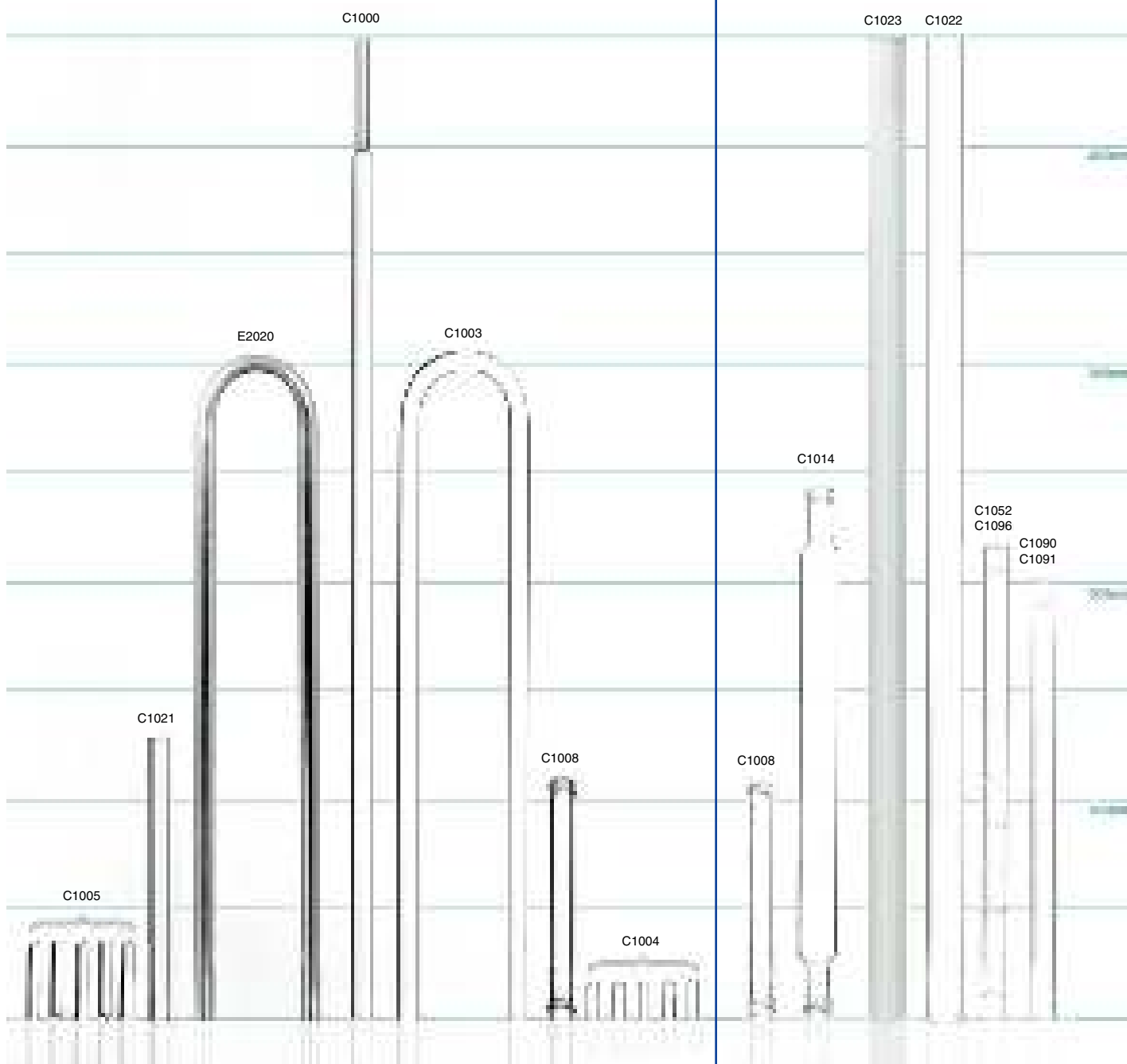

Elementar Vario EL

Description	Pack	OEM	Cat no.
Scrubber	1	22 160 200/4	C3008
Combustion/Reduction Tube	1	11 001 150/4	C3009
Lance 140mm	1	05 000 088	C3011
Lance 150mm	1	05 000 354	C3012
Lance 170mm	1	05 000 658	C3013
U Tube	1	22 160 301/4	C3015
Support Tube 133mm	1	11 001 171/4	C3016
Support Tube 65mm	1	11 001 172/4	C3017
Ash finger 60mm	1	11 001 170/4	C3018
Ash finger 105mm	1	11 001 317/4	C3021
Connecting Tube	1	11 00-1331/4	C3022

Elementar CHN Rapid

Description	Pack	OEM	Cat no.
Combustion Tube	1	22 156 202/3	C3004
Reduction Tube	1	22 127 245/3	C3005
U Tube	1	22 160 294	C3007
Scrubber	1	22 160 200/4	C3008
Pyrolysis Tube	1	22 133 210/3	C3019
Pyrolysis Insert	1	22 133 211/4	C3020
Insert CHN Rapid	1		C3023
Gauze Insert	1	22 127 313/4	D6001

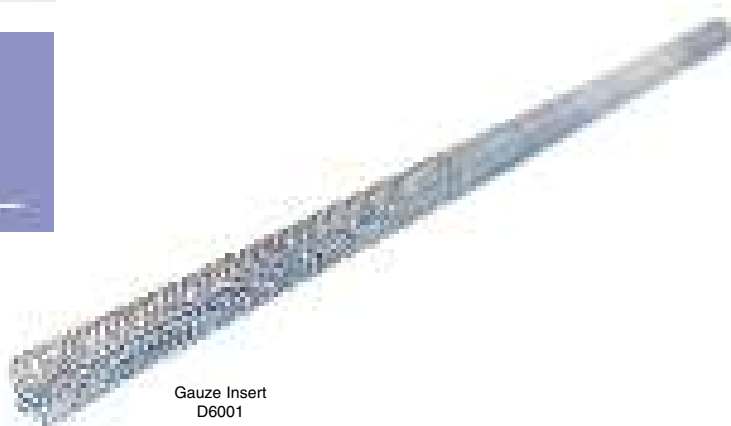
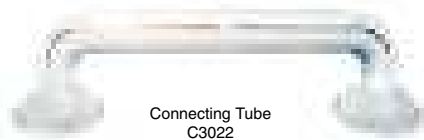

Pre-packed tubes for this instrument are available - please see configuration guide for details.

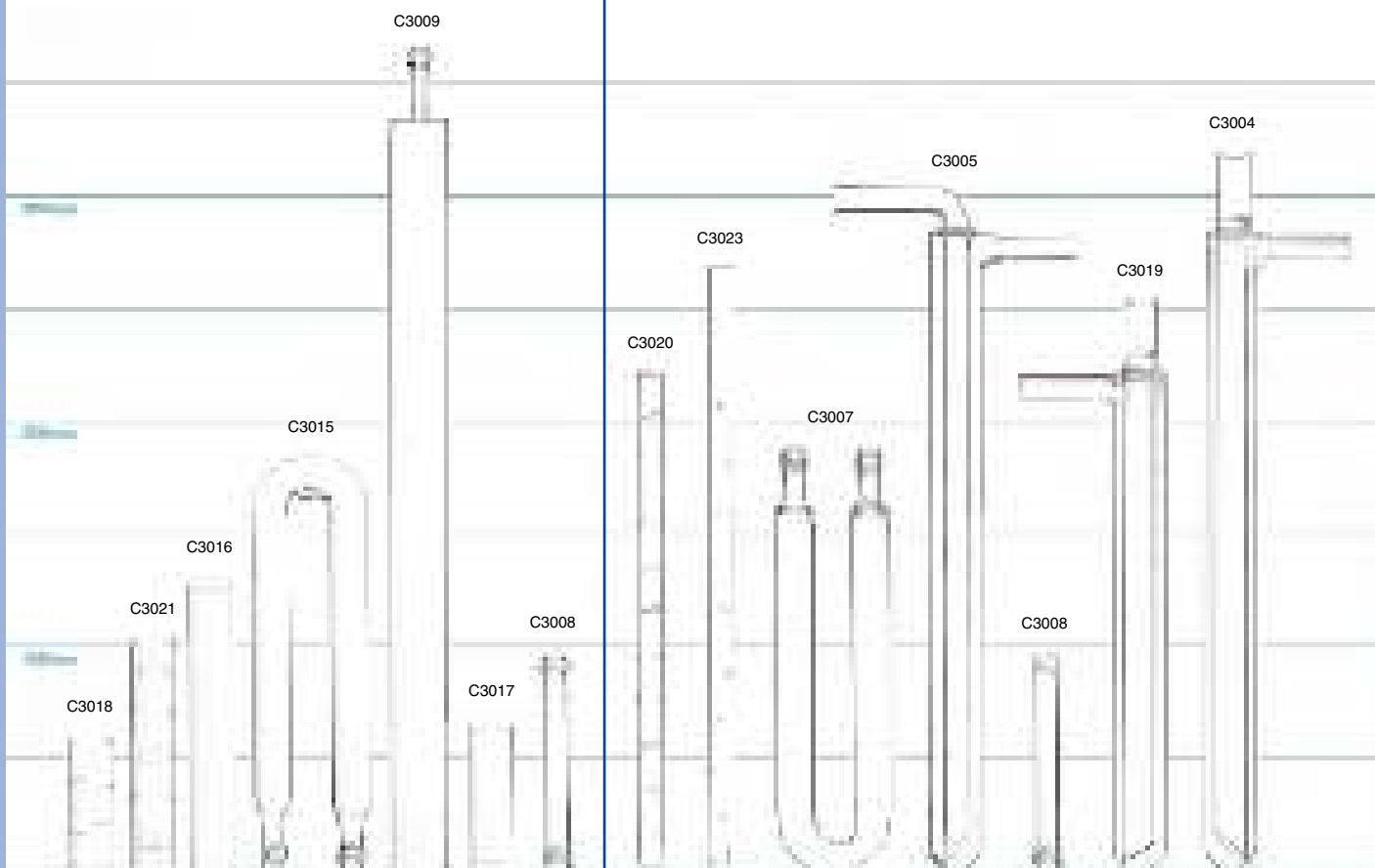

Perkin Elmer 2400

Leco® 900/932

Description	Pack	OEM	Cat no.
Combustion Tube	1	N241-1264	C2015
Reduction Tube	1	N241-1291	C2016
Pyrolysis Tube	1	N241-1235	C2018
Tube	1	N241-1300	C2019
Vial Recepticle Slitted Quartz	1		C2020
Scrubber Tube	1	N241-1359	C2021
Combustion tube	1	N241-1514	C2024
Vial Recepticle Slitted Quartz	1	N241-1401	C2025
Combustion Tube (Pack of 5xC2015)	1	N241-0212	C2038
Reduction Tube (Pack of 5xC2016)	1	N241-0154	C2039

Description	Pack	OEM	Cat no.
Reaction/Reduction tube	1	605-875	C4002
Filter Tube Quick n Easy 11 to 11mm	1	775-601	C4004
Catalyst Heater Tube	1	776-279	C4006
Lance Tube	1	604-541	C4033
Reagent tube	1	774-368	C4337

Pre-packed tubes for this instrument are available - please see configuration guide for details.

Pre-packed tubes for this instrument are available - please see configuration guide for details.

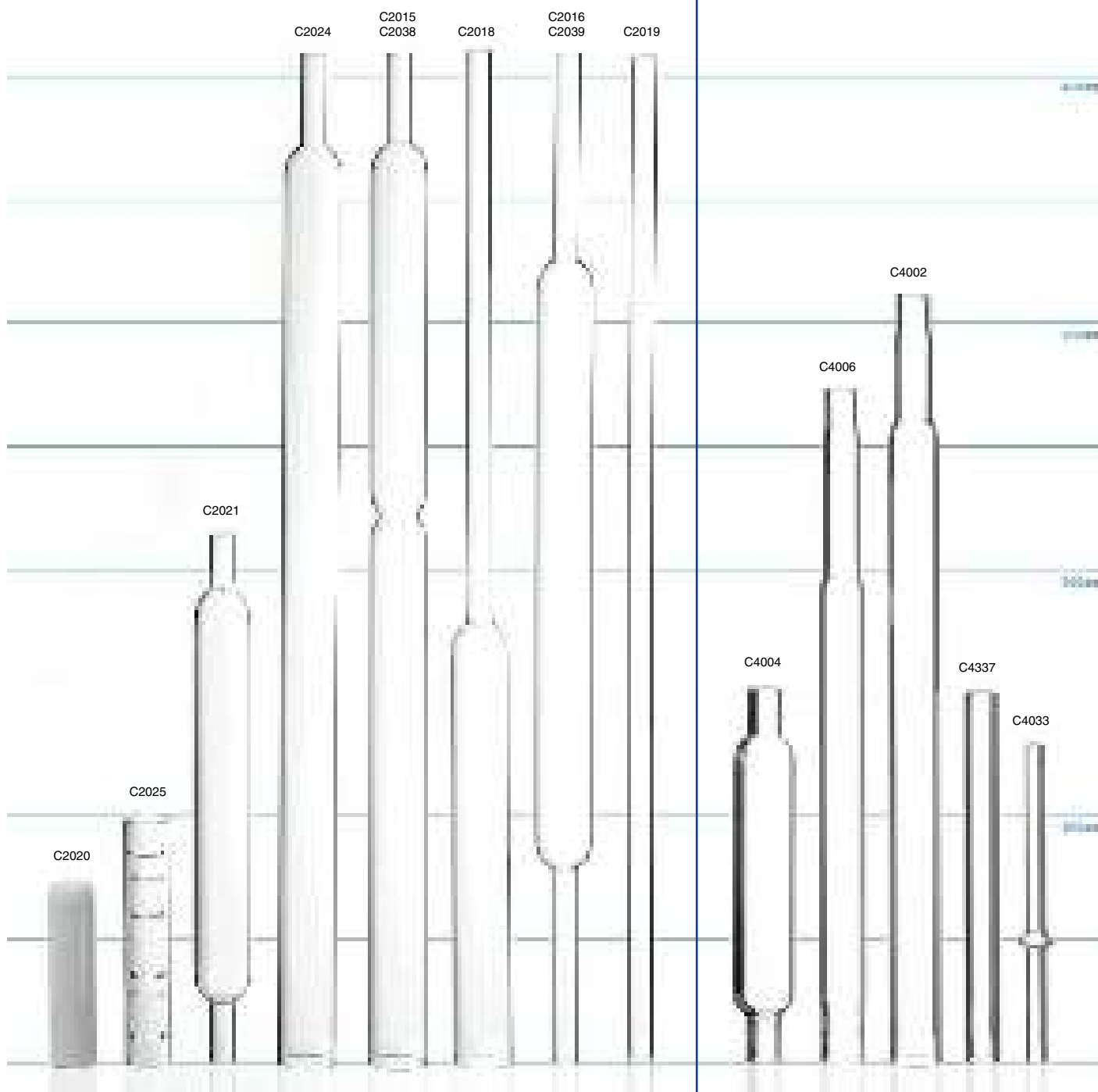

Europa

Description	Pack	OEM	Cat no.
Reduction Tube	1	C1001014	C1030
Scrubber	1	C1001015	C1032
Reaction/Reduction Tube, transparent	1	C1001012	C1040
Reaction/Reduction Tube, translucent	1	C1001013	C1041
Sleeve insert 180mm (Open both ends)	1	C1001048	C1050
Scrubber	1	E1002687	C1063
Sleeve insert 220mm (Open both ends)	1		C1094
Sleeve insert 220mm (Closed one end)	1		C2030

Eurovector

Description	Pack	OEM	Cat no.
Trap			C1008
Trap			C1014
Sleeve insert 235mm (Closed one end)	1		C1051
Sleeve insert 220mm (Closed one end)	1		C1052
Reaction tube modified, transparent/translucent	1		C1055
Reaction tube modified transparent	1	E12512	C1056
Reaction tube, transparent, pack of 2	1	E12509	C1074
Reaction tube, translucent, pack of 2	1	E12508	C1084
Reaction tube, quartz 20/6, transparent	1	E12520	C1083
Reaction tube, quartz 20/6, translucent	1	E12525	C1088
Sleeve insert 205mm (Open both ends)	1		C1090
Sleeve insert 205mm (Closed one end)	1		C1091
Sleeve insert 235mm (Open both ends)	1		C1093
Sleeve insert 220mm (Open both ends)	1		C1096
Reaction Tube	1	E12510	C1099
Ceramic Tube	1	E12507	C1102

Pre-packed tubes for this instrument are available - please see configuration guide for details.

Pre-packed tubes for this instrument are available - please see configuration guide for details.

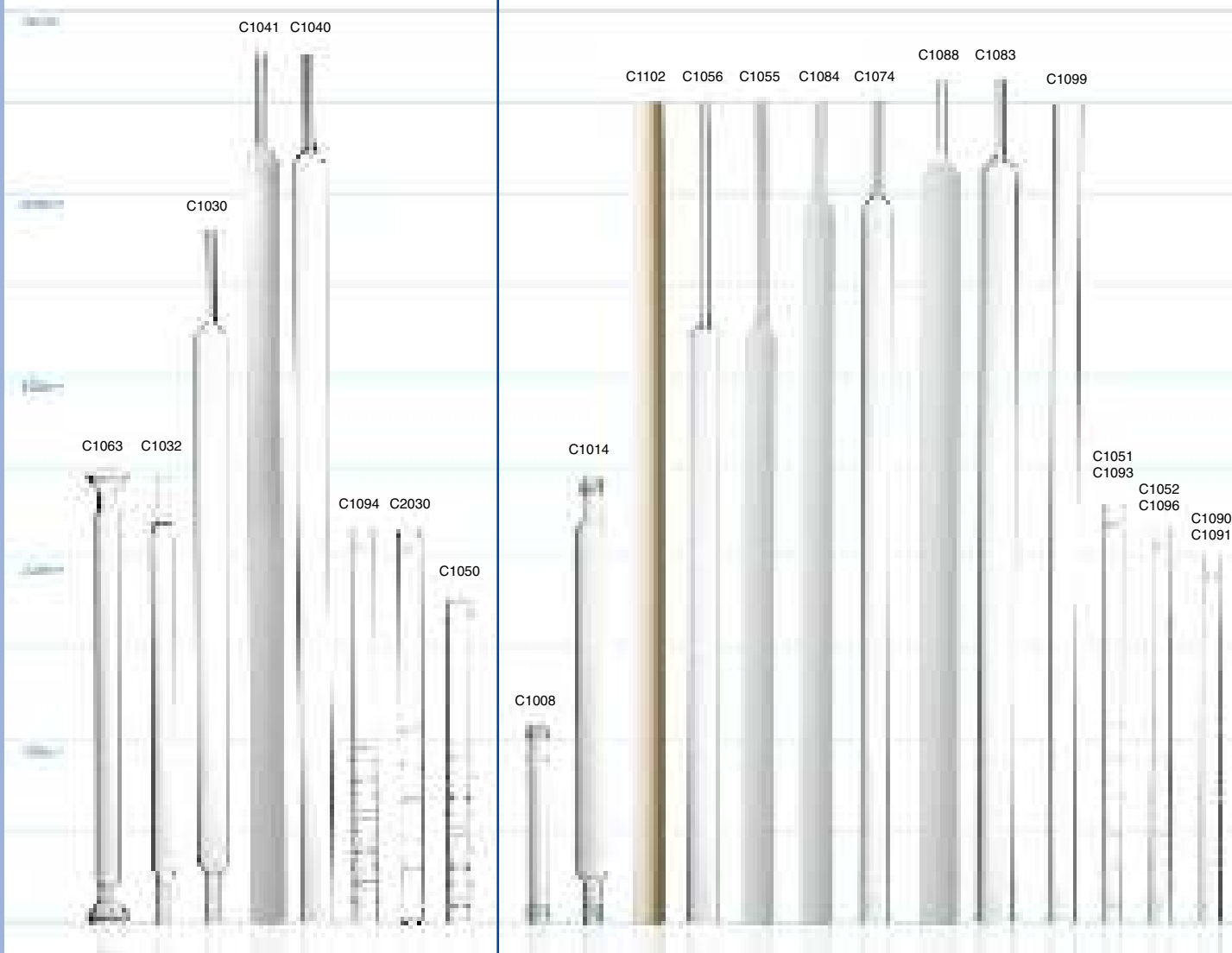

Exeter

CHN Mode Combustion Tubes



Product	Pack	E part	Cat no
Combustion tube, CHN, SAI, 25.25"	1	0240-1225	C6000
Combustion tube, CHN, SHA, 16.25"	1	6703-0514	C6001
Combustion tube, CHN, SHA, anti-jetting, 16.25"	1	6703-0585	C6002
Combustion tube, CHN, HA, 16.75"	1	6703-0378	C6003

Oxygen Mode Pyrolysis Tubes

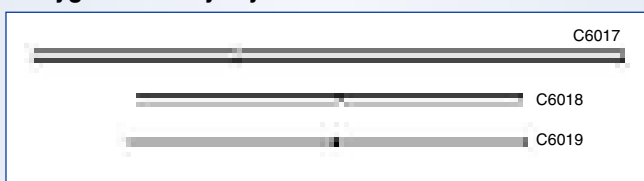

Product	Pack	E part	Cat no
Pyrolysis tube, oxygen, SAI, 26"	1	0240-1962	C6017
Pyrolysis tube, oxygen, SHA, 17"	1	6703-0565	C6018
Pyrolysis Tube, oxygen, HA, 17.5"	1	6703-0406	C6019

Sulphur Mode Combustion Tubes



Product	Pack	E part	Cat no
Combustion tube, sulphur, SAI, 27.75"	1	0240-1369	C6006
Combustion tube, sulphur, SHA, 18.75"	1	6703-0581	C6007
Combustion tube, sulphur, HA, 19.25"	1	6703-0580	C6008

Scrubbers, Traps and Connector Tubes

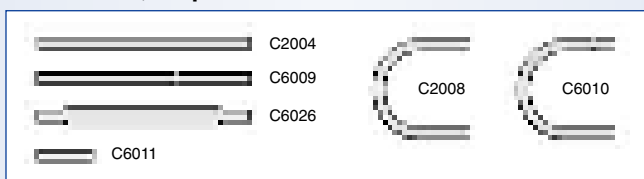

Product	Pack	E part	Cat no
Scrubber tube, CHN/O, 8"	4	0240-1217	C2004
Scrubber tube, sulphur, 8"	1	0240-1372	C6009
Scrubber tube, large diameter, 8"	1	0240-0217B	C6026
U tube, oxygen	1	0240-1356	C2008
U tube, sulphur	1	0240-1371	C6010
Drive box connector tube, 2.5"	1	-	C6011

Exeter

Ladles

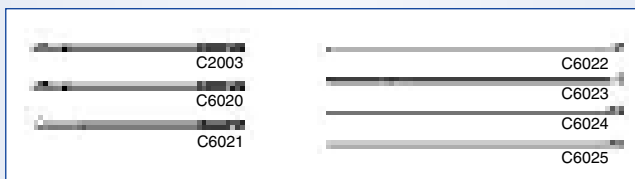

Product	Pack	E part	Cat no
Magnetic ladle, SAI	1	0240-1321	C2003
Magnetic ladle, SAI, with cut-out	1	0240-1724A	C6020
Magnetic ladle, SAI, refractories	1	0240-2061A	C6021
Ladle, SHA, straight	1	6703-0503	C6022
Ladle, SHA, anti-jetting	1	6703-0584	C6023
Ladle, HA 64, curved	1	6703-0376	C6024
Ladle, HA 64, small diameter	1	6703-0589	C6025

Reduction Tubes and Secondary Reactor Tubes

Note: Our CEC type silicaware has circular grooves to form constrictions.

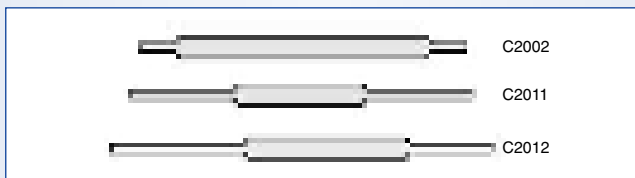

Product	Pack	E part	Cat no
Reduction tube, CHN, 14.5"	1	0240-0573	C2002
Secondary reactor tube, oxygen, 15.25"	1	0240-1963	C2011
Reduction tube, sulphur, 17"	1	0240-1961	C2012

Carlo Erba/ThermoFinnigan

Product	Pack	OEM	Cat no
O-ring, Viton	10	29050567	E1000
O-ring, Viton	10	29030331	E1001
O-ring, Nitrile	10	29050306	E1002
O-ring, Nitrile	10		E1003
O-ring, Nitrile	10		E1004
O-ring, Nitrile	1	29005046	E1008
Bi-pneumatic Valve Diaphragm	1	31302100	E1011
O-ring, Nitrile	10	29050304	E1020
O-ring, Schott Type Silicone/PTFE	10	29013603	E1021
O-ring, Nitrile	10	29050301	E1022
Seal Viton Chamfered Square Profile	5	29032910	E1041
Seal Viton Chamfered Square Profile	5	29030042	E1042
Seal Viton Chamfered Square Profile	5	29050306	E1043

O-rings shown actual size



Eurovector

Product	Pack	OEM	Cat no
O-ring viton for 10/11mm od	10	E13520	E1500
O-ring	10		E1502
O-ring EVR for holder	2	E13535	E1503
O-ring EVR for reactor 18mm od	1	E13536	E1504
O-ring EVR for bottom quick fit 18mm	1	E13537	E1505
O-ring for ceramic reactor 17mm	1	E13538	E1506
O-ring EVR for bottom quick fit 17mm	1	E13539	E1507
O-ring viton bottom quick fit 6mm	1	E13540	E1508

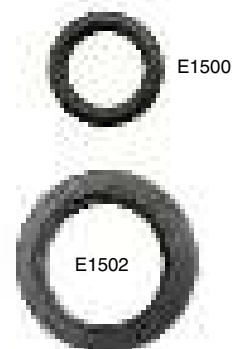

O-rings shown actual size

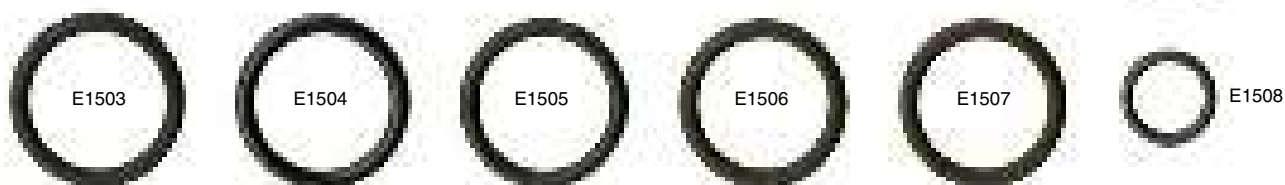

Perkin Elmer

Product	Pack	OEM	Cat no
O-ring Nitrile	10	0990-2017	E1005
O-ring Nitrile	10	0240-1582	E1006
O-ring Viton	10	0240-1581	E1007
O-ring Silicone	10	0990-2188	E1009
O-ring Nitrile	1	0990-2048	E1010
O-ring Viton	10	0240-1583	E1013
O-ring Nitrile	2	0990-2123	E1014
O-ring Nitrile	2	0240-1293	E1015
O-ring Viton	1	0240-2133	E1019

O-rings shown actual size

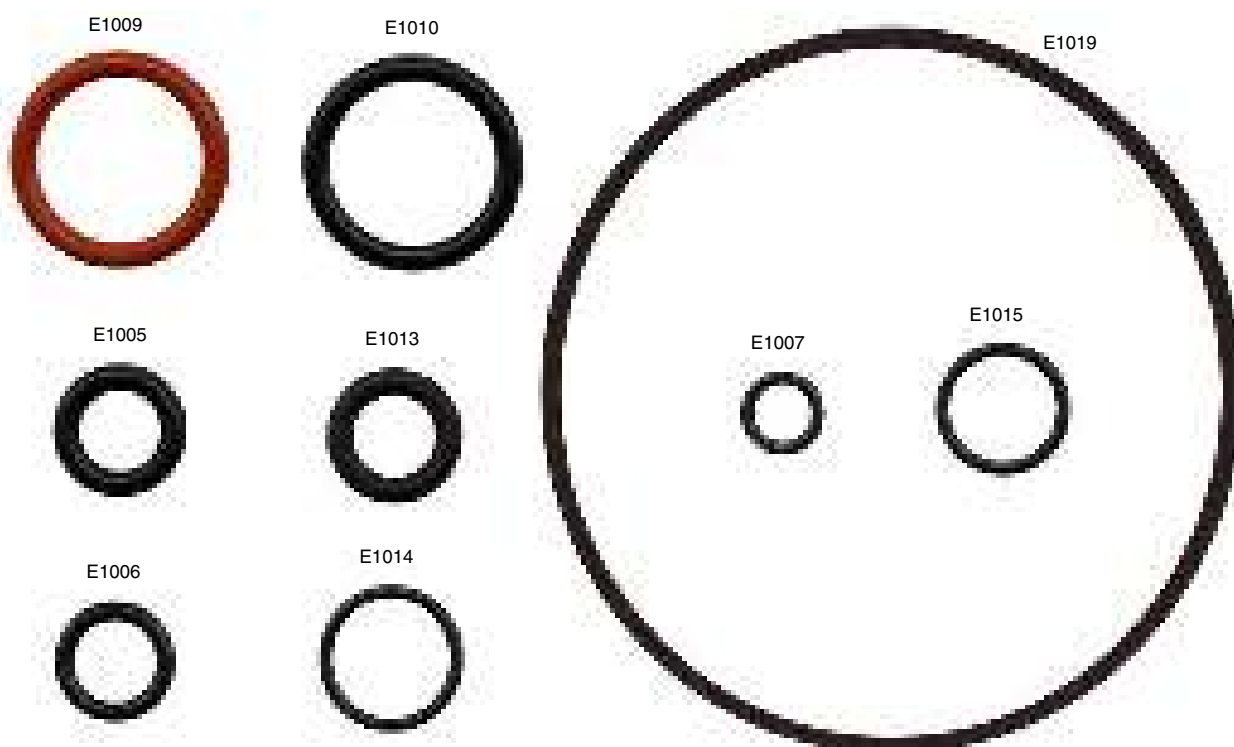

Leco®

Product	Pack	OEM	Cat no
O-ring Sample Drop Block	1	772-910	E1100
O-ring Combustion/Catalyst/Filter Tube	1	605-828	E1105
O-ring Furnace Filter/Filter Tube	1	772-520	E1110
O-ring Catalyst Heater Assembly	1	772-738	E1111
O-ring Sample Drop Block	1	589-551	E1112
O-ring Catalyst/Reaction Tube	1	605-830	E1126
O-ring Lance Tube	1	760-224	E1127
O-ring Sample Drop Block	1	774-283	E1129
O-ring Sample Drop Block Piston	1	774-613	E1130
O-ring Catalyst Heater Tube	1	778-114	E1131
Seal Viton	1	589-305	E1132
O-ring Filter Tube	1	765-976	E1133

O-rings shown actual size



Elementar

Product	Pack	OEM	Cat no
O-ring Silicone	10	03 654 603	E1016
O-ring Viton	1	03 654 772	E1017
Seal Viton	1	05 000 247	E1050
O-ring Kalrez	1	05 000 383	E1051
O-ring Kalrez	1	05 000 382	E1052
O-ring Viton	1	05 000 341	E1053
Quadring Viton	1	05 000 353	E1054
O-ring Silicone	1	03 654 814	E1055
O-ring Viton	1	05 000 369	E1057
Tubing PTFE 5mm OD x 3mm ID 0.5m	1	03 651 011	E1058
O-ring Nitrile	1	05 000 140	E1060
O-ring Kalrez	1	05 000 092	E1061
O-ring Silicone	1	05 000 043	E1062
O-ring Silicone	1	03 653 103	E1063
O-ring Silicone	1	03 654 629	E1066
O-ring Viton	1	05 000 249	E1067
O-ring Viton	1	05 000 385	E1068
O-ring Viton	1	05 000 416	E1069
O-ring Viton	1	05 000 359	E1070

Product	Pack	OEM	Cat no
O-ring Nitrile	1	05 000 368	E1071
O-ring Viton	1	05 000 096	E1072
O-ring Viton	1	03 654 627	E1073
O-ring Viton	1	05 000 095	E1074
O-ring Viton	1	03 002 267	E1075
O-ring Viton	1	05 000 371	E1076
O-ring Viton	1	05 000 372	E1077
Quadring Nitrile	1	05 000 384	E1078
Sealing Ring	1	03 667 990	E1079
Sealing Ring	1	03 667 991	E1080
O-ring Nitrile	1	03 654 615	E1081
O-ring Silicone	1	03 654 701	E1082
O-ring Silicone	1	05 000 248	E1083
O-ring Silicone	1	03 653 118	E1085
O-ring Silicone	1	03 654 505	E1086
O-ring Silicone	1	03 654 772	E1088
O-ring Silicone	1	03 679 941	E1090
Shaft Seal	1	03 002 607	E1555

Elementar O-rings & Seals

O-rings shown actual size



PTFE Tubing
5mm OD x 3mm ID
Length 0.5m
E1058

(not shown actual size)

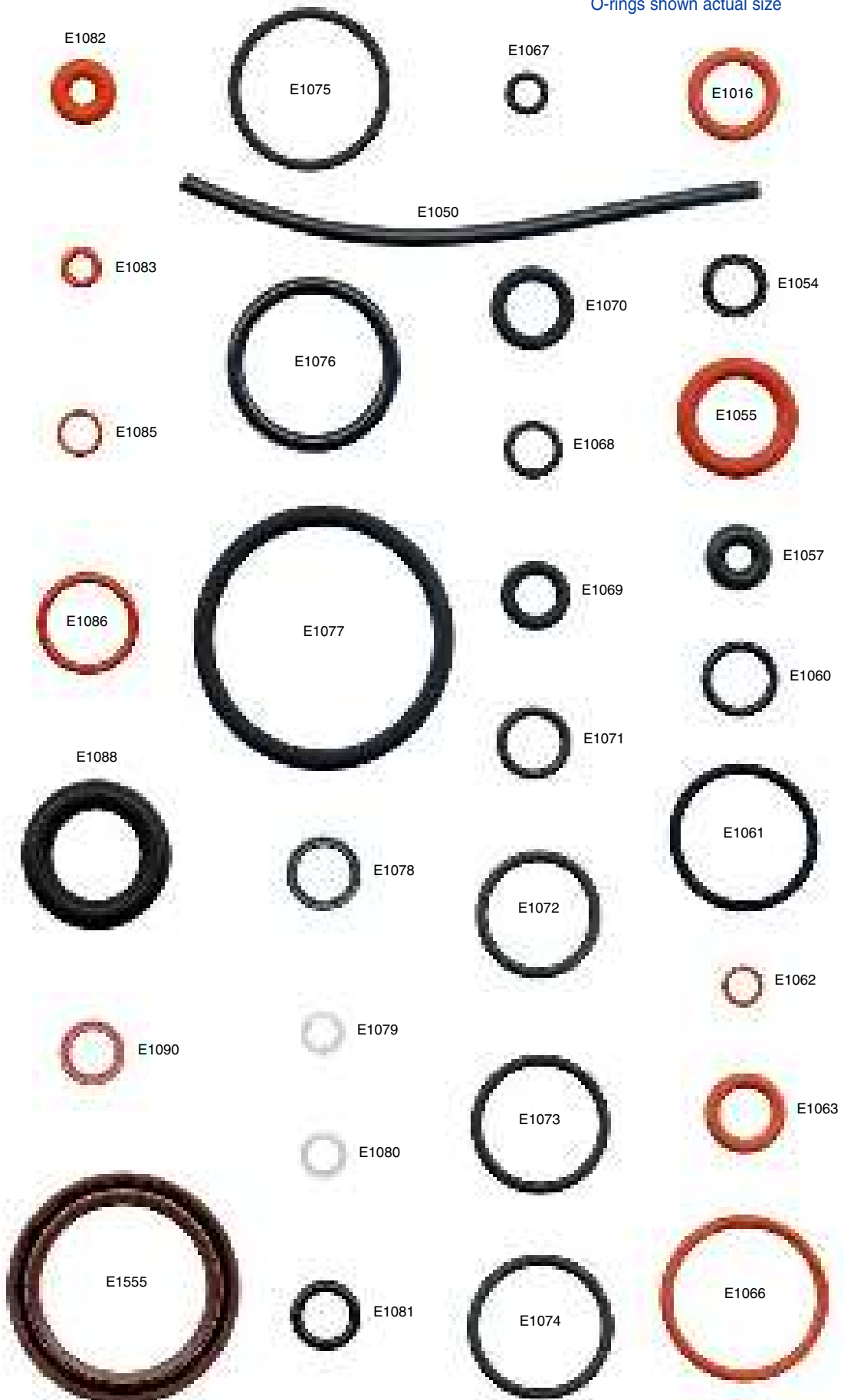

Costech

Product	Pack	OEM	Cat no
O-ring Schott Type Silicone/PTFE	10	29013603	E1021
Seal Viton Chamfered Square Profile	5	29032910	E1041

E1021
(Both sides shown)



E1041

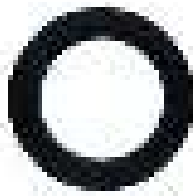

Europa

Product	Pack	OEM	Cat no
O-ring Viton	10		E1001
O-ring Nitrile	10		E1004
Seal Viton Chamfered Square Profile	5		E1042
O-ring	1	E1005669	E1420
O-ring	1	E1002684	E1421

E1001

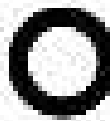

E1004

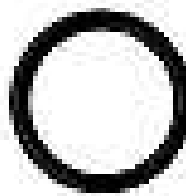

E1042

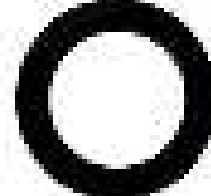

E1420



E1421



Exeter

Product	Pack	OEM	Cat no
O Ring Nitrile	10	0990-2017	E1005
O Ring Nitrile	10	0240-1582	E1006
O Ring Viton	10	0240-1581	E1007
O Ring Viton	10	0240-1583	E1013
O Ring Nitrile	2	0240-1293	E1015
O Ring Nitrile	1	316-00003	E1032
O Ring Nitrile	1	316-00008	E1033

O-rings shown actual size

E1032

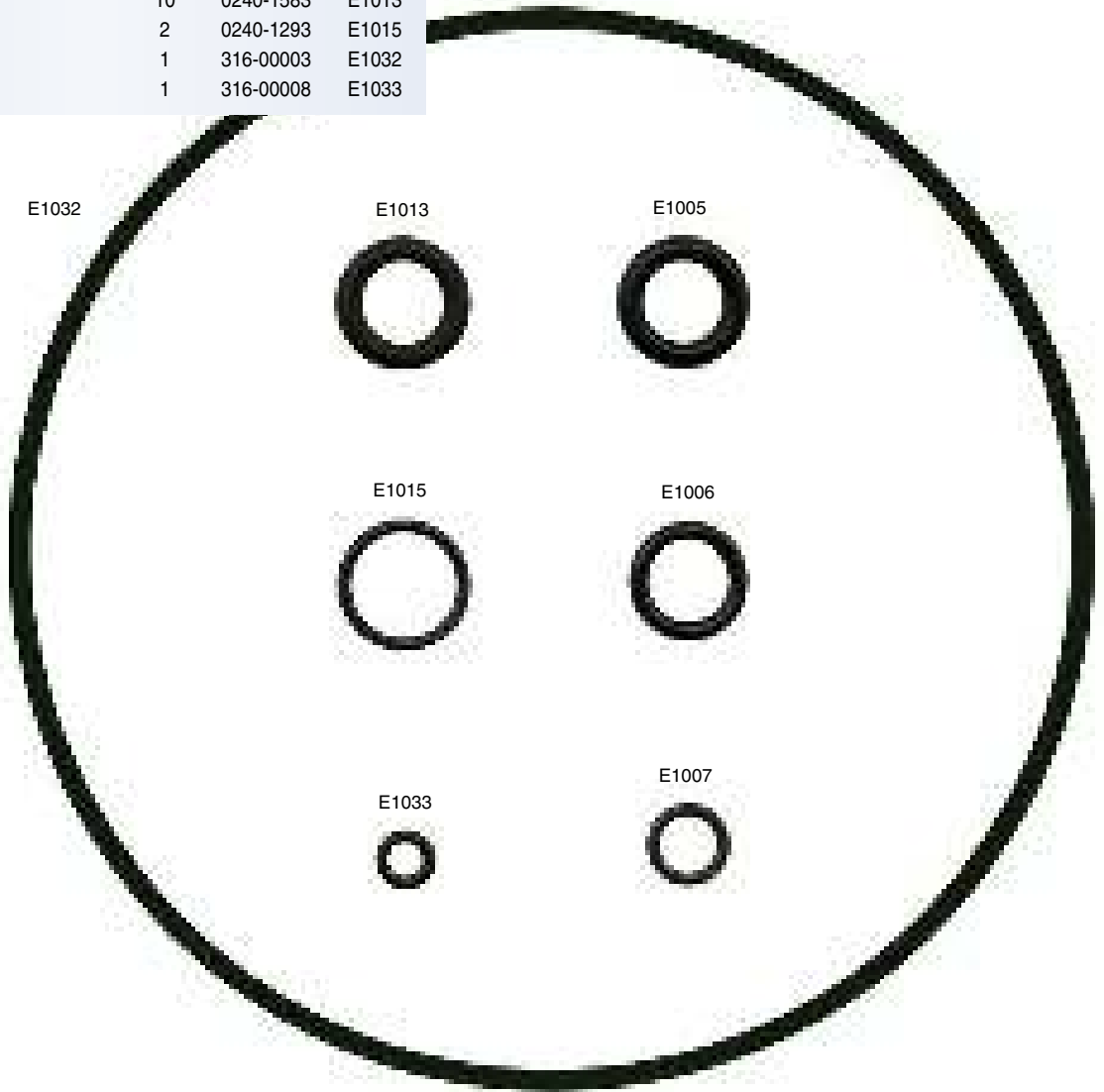

E1013

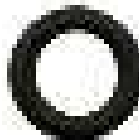

E1005

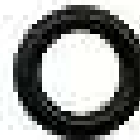

E1015

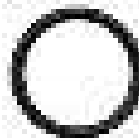

E1006

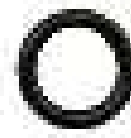

E1033



E1007



A good separation column is essential for the accurate functioning of any chromatographic elemental analyser. Elemental Microanalysis columns are carefully manufactured and tested for optimum performance.

CHN Separation Columns

Column	Pack	CE/Thermo	Costech	Eurovector	Europa
E3000 2m SS	1	260 08200	051081	E11505	-
E3006 2m SS	1	260 08000	-	-	-
E3020 2m PTFE	1	260 08207	-	-	-

NCHS Separation Columns



Column	Pack	CE/Thermo	Costech	Eurovector	Europa
E3003 2m SS	1	260 08206	051080	E11501	-
E3013 2m PTFE	1	260 08208	-	E11507	-

NC Columns

Column	Pack	CE/Thermo	Costech	Eurovector	Europa
E3004 3m SS	1	260 08205	051082	E11510	-
E3008 4m SS	1	-	051085	-	-
E3031 0.5m SS	1	-	-	-	E1004907

Nitrogen Columns

Column	Pack	CE/Thermo	Costech	Eurovector	Europa
E3005 2m SS	1	260 70004	-	-	-

Oxygen Columns

Column	Pack	CE/Thermo	Costech	Eurovector	Europa
E3001 1m SS	1	260 07900	051084	E11520	-
E3016 2m SS	1	-	051088	-	-
E3030 1m SS	1	-	-	-	C1001070

Sulphur Columns



Column	Pack	CE/Thermo	Costech	Eurovector	Europa
E3002 0.8m PTFE	1	260 07800	051083	E11515	-

Trace Columns

Column	Pack	CE/Thermo	Costech	Eurovector	Europa
E3007 0.5m PTFE	1	260 18500	-	-	-

Nitrogen/Protein Columns

Column	Pack	CE/Thermo	Costech	Eurovector	Europa
E3022 0.5m PTFE	1	260 07820	-	-	-

All columns are supplied conditioned and tested.

Oxygen Flask Combustion Equipment

Oxygen Flasks

Our oxygen flasks conform to BS2735 and are available in borosilicate or silica glass.

We can manufacture oxygen flasks in designs other than those listed if required. Please enquire for further information about this service.

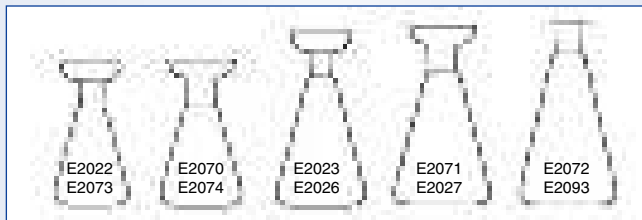

Description	Pack	Cat no.
Oxygen flask, borosilicate, 250 ml, B24	1	E2022
Oxygen flask, borosilicate, 500 ml, B24	1	E2023
Oxygen flask, borosilicate, 250 ml, B29	1	E2070
Oxygen flask, borosilicate, 500 ml, B29	1	E2071
Oxygen flask, borosilicate, 750 ml, B29	1	E2080
Oxygen flask, borosilicate, 500 ml, B34	1	E2106
Oxygen flask, transparent silica, 250 ml, B24, for fluorine	1	E2073
Oxygen flask, transparent silica, 500 ml, B24, for fluorine	1	E2026
Oxygen flask, transparent silica, 1000 ml, B29, for fluorine	1	E2103
Oxygen flask, transparent silica, 250 ml, B29, for fluorine	1	E2074
Oxygen flask, transparent silica, 500 ml, B29, for fluorine	1	E2027
Oxygen flask, 750 ml, B29, for use with Heraeus oxygen flask combustion unit, borosilicate	1	E2072
Oxygen flask, 750 ml, B29, for use with Heraeus oxygen flask combustion unit, silica, for fluorine determination	1	E2093

Oxygen Flask Stoppers

Available in borosilicate or silica glass.

We can manufacture oxygen flask stoppers in designs other than those listed below or attach platinum baskets as required. Please enquire for more details.



Description	Pack	Cat no.
Stopper, borosilicate, B24, with hook	1	E2024
Stopper, borosilicate, B29, with hook	1	E2081
Stopper, transparent silica, B24, with hook	1	E2028
Stopper, transparent silica, B29, with hook	1	E2029

Platinum Baskets for Oxygen Flask Combustions

Elemental Microanalysis platinum baskets are of fully welded construction in 99.9% platinum. Edges and rims are folded and welded to reduce fraying. Baskets are available for use in upright or inverted oxygen flasks.

Description	Pack	Cat no.
Platinum basket for upright flask, platinum, 20 x 7 mm basket, 1 mm dia. stem 70 mm long, 2.2 g	1	D7005
Platinum basket for inverted flask, platinum, 20 x 7 mm basket, 1 mm dia. stem 70 mm long, 2.2 g	1	D7007

Oxygen Flask Combustion Equipment

Platinum Flags for Oxygen Flask Combustions

Elemental Microanalysis platinum flags are of fully welded construction in 99.9% platinum. Edges and rims are folded and welded to reduce fraying.

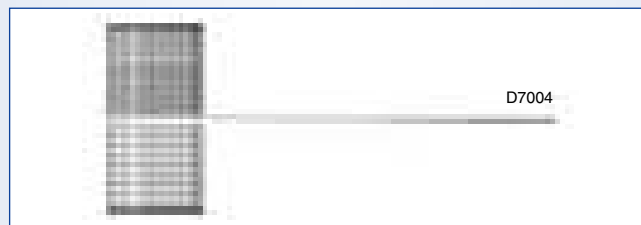

Description	Pack	Cat no.
Platinum flag, 15 x 30 mm, platinum, 1 mm dia. stem 70 mm long, 2.3 g	1	D7004

We can repair platinum baskets and flags at a fraction of the cost of a new replacement item. Please enquire for more information.

Platinum Micro-crucible



Description	Pack	Cat no.
Platinum micro-crucible, small handling lug, suitable for ashing, capacity 1 ml, height 13 mm, ID 12 mm, base 7.5 mm, weight 2 g	1	D7008
Platinum lid for D7008	1	D7009

We can also supply platinum crucibles in other sizes. Please enquire for details.

Other Micro-chemical Platinumware



Description	Pack	Cat no.
Platinum gauze catalyst strip, 12 x 150 mm, weight 260 mg	1	D7006
Platinum gauze catalyst strip, 20 x 200 mm, weight 325 mg	1	D7014
Platinum sheet, 50 x 50 x 0.05 mm	1	D7012
Platinum sheet, 50 x 50 x 0.1 mm	1	D7013
Platinum wire, diameter 1 mm, length 150 mm	1	D7015

We can manufacture special items in platinum and supply platinum sheet, wire and gauze in other sizes and specifications. We can also repair platinumware at a fraction of the cost of a new replacement item. Please enquire for more information about either of these services.

Oxygen Flask Combustion Equipment

Oxygen Flask Combustion Safety Equipment

Although the oxygen flask combustion technique is widely accepted as a safe method it is advisable to take safety precautions against the rare and unexpected. Oxygen flask combustion should be carried out behind a safety screen and protective gloves and safety spectacles or goggles should be worn.

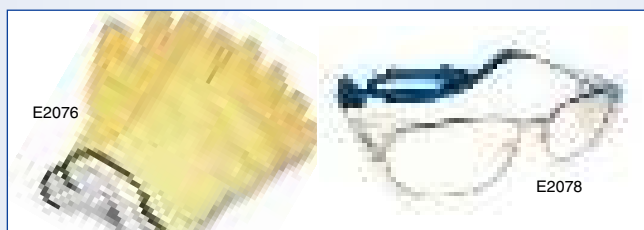

Description	Pack	Cat no.
Safety screen for oxygen flask combustions (flat 6 mm polycarbonate screen with heavy base)	1	E2075
Safety gloves, kevlar, extended cuff, cut resistant, suitable for oxygen flask combustions (state S, M or L when ordering)	1 pair	E2076
Safety glasses, metal frame, conform to BS 2092:2	1	E2078

Microanalytical Tools and Sundries

Disposable glass micro-pipettes

A range of graduated micro-sampling pipettes for loading liquids into smooth wall capsules. The graduations are a guide to the amount dispensed. For most liquids 1 microlitre is approximately 1 mg.

Supplied with mouthpiece, pipette connection and length of tubing.
For efficient pipetting we recommend the use of our micro-pipette filler.



Description	Pack	Cat no.
Micro-pipettes, disposable, calibrated 5 µlitre in divisions of 1 µlitre, borosilicate	250	E2008
Micro-pipettes, disposable, calibrated 5 microlitre, borosilicate	250	E2052
Micro-pipettes, disposable, calibrated 10 microlitre, borosilicate	250	E2053
Micro-pipettes, disposable, calibrated 20 microlitre, borosilicate	250	E2054
Micro-pipettes, disposable, calibrated 25 microlitre, borosilicate	250	E2009
Micro-pipettes, disposable, calibrated 50 microlitre, borosilicate	250	E2055
Micro-pipettes, disposable, calibrated 100 microlitre, borosilicate	250	E2056
Micro-pipette filler, for above	1	E2045

Pasteur (Dropping) Pipettes

Description	Pack	Cat no.
Pipettes, Pasteur, glass, jet dia. 1.5 mm, jet length 60 mm, overall length 145 mm	250	E2057
Teat, pasteur pipettes, PVC with 1.5 ml uptake, 46 mm long x 15 mm OD, 7 mm bore	100	E2058

Microanalytical Tools and Sundries (cntd.)

Bubble Flowmeter, Timers

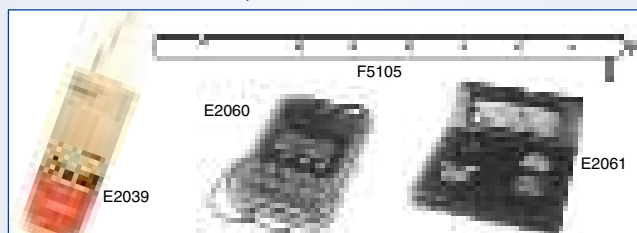

Description	Pack	Cat no.
Bubble flowmeter, 50 x 10 cc, for measuring gas flows in elemental analysers, complete with tubing, teat and magnetic clamps (Other sizes of flowmeter available - please enquire)	1	F5105
Snoop leak detecting fluid, also for use in bubble flowmeters	1	E2039
Digital stopwatch, hand held	1	E2060
Digital stop clock, bench version	1	E2061

Forceps

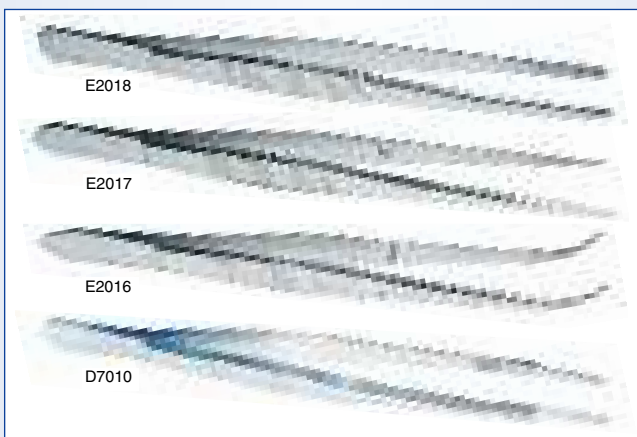

Description	Pack	Cat no.
Forceps, blunt ends, stainless steel, length 130 mm	1	E2018
Forceps, straight ends, stainless steel, length 130 mm	1	E2017
Forceps, curved ends, stainless steel, 130 mm	1	E2016
Platinum tipped forceps, stainless steel with welded platinum tips slightly milled on inner faces, length 130 mm, recommended for handling platinum	1	D7010

Tongs

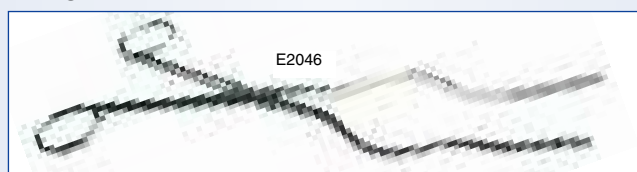

Description	Pack	Cat no.
Platinum tipped tongs, length 200 mm, stainless steel with platinum shoes, for handling platinum	1	D7011
Tongs, stainless steel, length 200 mm	1	E2046

Microanalytical Tools and Sundries (cntd.)

Micro-Spatula

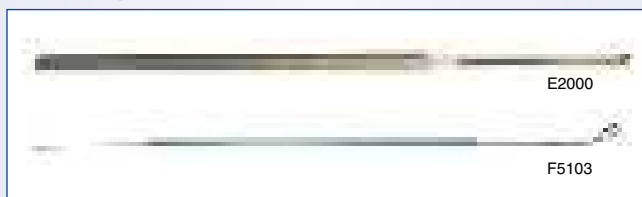

Description	Pack	Cat no.
Micro-spatula, stainless steel, length 150 mm, width 3 mm, thin blade with turned up end, hexagonal stainless handle	1	E2000
Micro Spatula	1	F5103

Micro-Dessicators

Ideal for use with platinum micro-crucibles and capsules. An optional platinum plate ensures the weight integrity of any hot platinumware placed on the surface.



Description	Pack	Cat no.
Micro-dessicator, 50 mm diameter, stainless perforated plate, borosilicate glass cover	1	E2007
Borosilicate glass cover, spare for E2007	1	E2048
Perforated platinum plate, optional extra for E2007	1	E2049
Silica gel, granular, indicating, suitable for use with E2007	100g	B1044

Screw Cap Sample Vials

A range of sample vials in clear glass complete with white bakelite screw caps. Supplied in small quantities for convenience.

Description	Pack	Cat no.
Screw cap vial, 2 ml, 11.25 x 36 mm	10	E2082
Screw cap vial, 3.5 ml, 12.75 x 46 mm	10	E2083
Screw cap vial, 7 ml, 16.75 x 58 mm	10	E2084
Screw cap vial, 10 ml, 17.25 x 67 mm	10	E2085
Screw cap vial, 15 ml, 20.25 x 72 mm	10	E2086
Screw cap vial, 30 ml, 23.25 x 96 mm	10	E2087

Snap Cap Sample Vials

A range of sample vials in clear glass complete with 22 mm polyethylene snap caps. Supplied in small quantities for convenience.

Description	Pack	Cat no.
Snap cap vial, 7 ml, 23.25 x 34 mm	10	E2088
Snap cap vial, 10 ml, 24.5 x 41 mm	10	E2089
Snap cap vial, 15 ml, 25.25 x 48 mm	10	E2090
Snap cap vial, 20 ml, 26.25 x 60 mm	10	E2091
Snap cap vial, 30 ml, 27.5 x 72 mm	10	E2092

Microanalytical Tools and Sundries (cntd.)

Miscellaneous Items

Description	Pack	Cat no.
Drill, 6.5 x 400 mm, tungsten carbide tipped, for drilling out copper from E2020 reduction tube, can be used with an electric drill or with our Tee bar E2042	1	E2041
Tee bar, for use with E2041 drill	1	E2042
Mole grips, miniature, for simple, inexpensive crimping of liquid samples in smooth wall capsules	1	E2043
Tubing, stainless steel, 2 mm outside diameter	5 m	E2033
Tubing, PTFE, 2 mm outside diameter	3 m	E2030
Multiwell plate, 96 x 0.37 ml cells, flat bottom	1	E2044
Multiwell plate, 96 x 0.37 ml cells, round bottom	1	E2062
Multiwell plate, 48 x 1.5 ml cells, flat bottom	1	E2063
Multiwell plate, 24 x 3.4 ml cells, flat bottom	1	E2064
Multiwell plate, 12 x 6.9 ml cells, flat bottom	1	E2065
Multiwell plate, 6 x 16.8 ml cells, flat bottom	1	E2066





Configuration Guide

CHNOS Analysis

N DETERMINATION

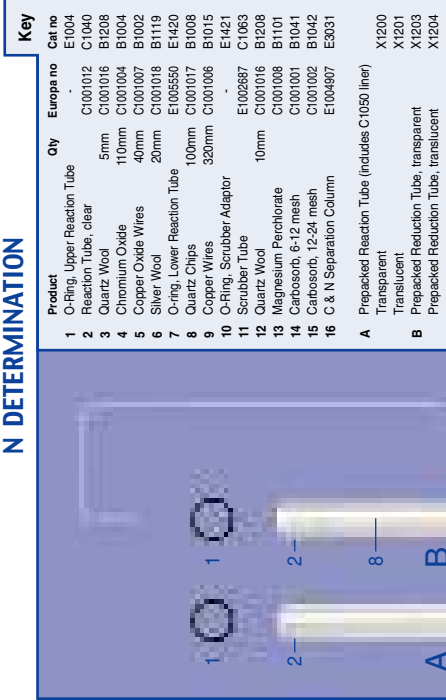

Product		Qty	Europa no	Cat no
1	O-Ring, Upper Reaction Tube		C1001012	E1004
2	Reaction Tube, clear	5mm	C1001016	B1208
3	Quartz Wool	110mm	C1001004	B1004
4	Chromium Oxide	40mm	C1001007	B1002
5	Copper Oxide Wires	20mm	C1001018	B1119
6	Silver Wool	100mm	E1005550	E1420
7	O-Ring, Lower Reaction Tube	320mm	C1001006	B1008
8	Copper Wires		C1001007	B1015
9	Quartz Chips		E1002897	E1421
10	O-Ring, Scrubber Adaptor		E1002897	C1063
11	Scrubber Tube	10mm	C1001016	B1208
12	Quartz Wool		C1001008	B1101
13	Magnesium Perchlorate		C1001001	B1041
14	Carbosorb, 6-12 mesh		C1001002	B1042
15	Carbosorb, 12-24 mesh		E1004807	E3031
16	C & N Separation Column			
A Prepacked Reaction Tube (includes C1050 liner)				X1200
	Transparent			X1201
B Prepacked Reduction Tube, transparent				X1203
	Prepacked Reduction Tube, translucent			X1204

N & C DETERMINATION

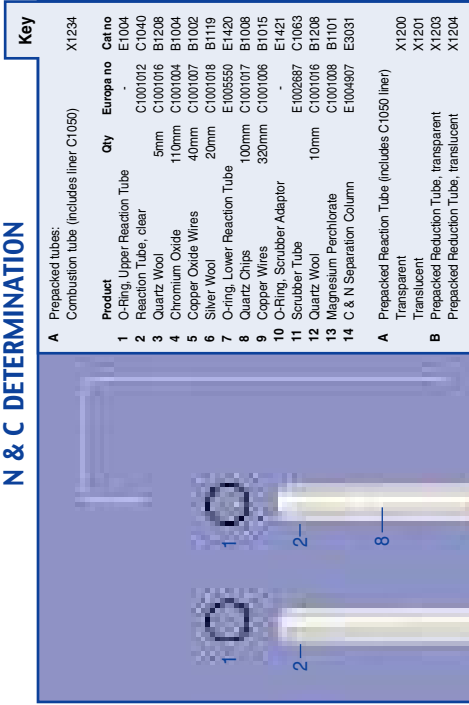

Product		Qty	Europa no	Cat no
A Prepacked tubes:				X1234
Combustion tube (includes liner C1050)				E1004
1	O-Ring, Upper Reaction Tube		C1001012	C1040
2	Reaction Tube, clear	5mm	C1001016	B1208
3	Quartz Wool	110mm	C1001004	B1004
4	Chromium Oxide	40mm	C1001007	B1002
5	Copper Oxide Wires	20mm	C1001018	B1119
6	Silver Wool	100mm	E1005550	E1420
7	O-Ring, Lower Reaction Tube	320mm	C1001006	B1008
8	Copper Wires		C1001007	B1015
9	Quartz Chips		E1002897	E1421
10	O-Ring, Scrubber Adaptor		E1002897	C1063
11	Scrubber Tube	10mm	C1001016	B1208
12	Quartz Wool		C1001008	B1101
13	Magnesium Perchlorate		E1004807	E3031
14	C & N Separation Column			
A Prepacked Reaction Tube (includes C1050 liner)				X1200
	Transparent			X1201
B Prepacked Reduction Tube, transparent				X1203
	Prepacked Reduction Tube, translucent			X1204

S DETERMINATION

Product		Qty	Europa no	Cat no
1	O-ring, upper		E1005551	E1004
2	Reaction Tube		C1001012	C1040
3	Quartz Wool	5mm	C1001016	B1208
4	Tungstic Oxide on Zirconia	90mm	-	B1082
5	Copper Wires, high purity	80mm	C1001042	B1035
6	Quartz Chips	10mm	C1001017	B1008
7	O-ring, lower		E1005550	E1420
8	GC Column for S			
A Prepacked Reaction/Reduction Tube				X1205
	Transparent			X1206
	Translucent			

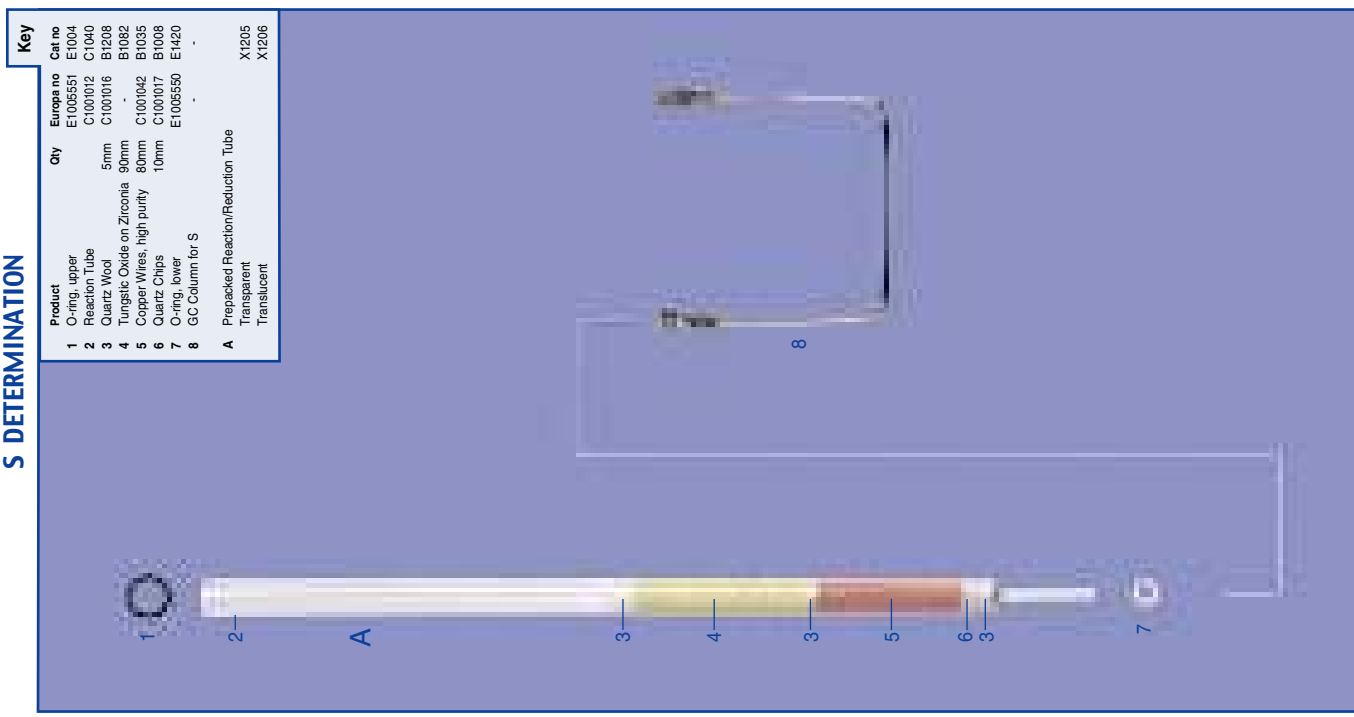

O PYROLYSIS

Key	
Product	Cat no
1 O-Ring, upper	E1004
2 Combustion Tube	C1040
3 50% Nickelised Carbon	B1182
4 Glassy Carbon Chips 2.3mm	C7003
5 Quartz Wool	B1208
6 O-Ring, lower	E1420
7 O-Ring, scrubber tube	E1421
8 Scrubber Tube	E102887
9 Quartz Wool	C100106
10 Magnesium Perchlorate	B1208
11 Carbosorb 6-12 mesh	B1101
12 Carbosorb 12-24 mesh	C1001001
13 GC separation column	B1042
A Prepared Oxygen Pyrolysis Tube	E3030
Translucent	X1207
Prepacked	X1208

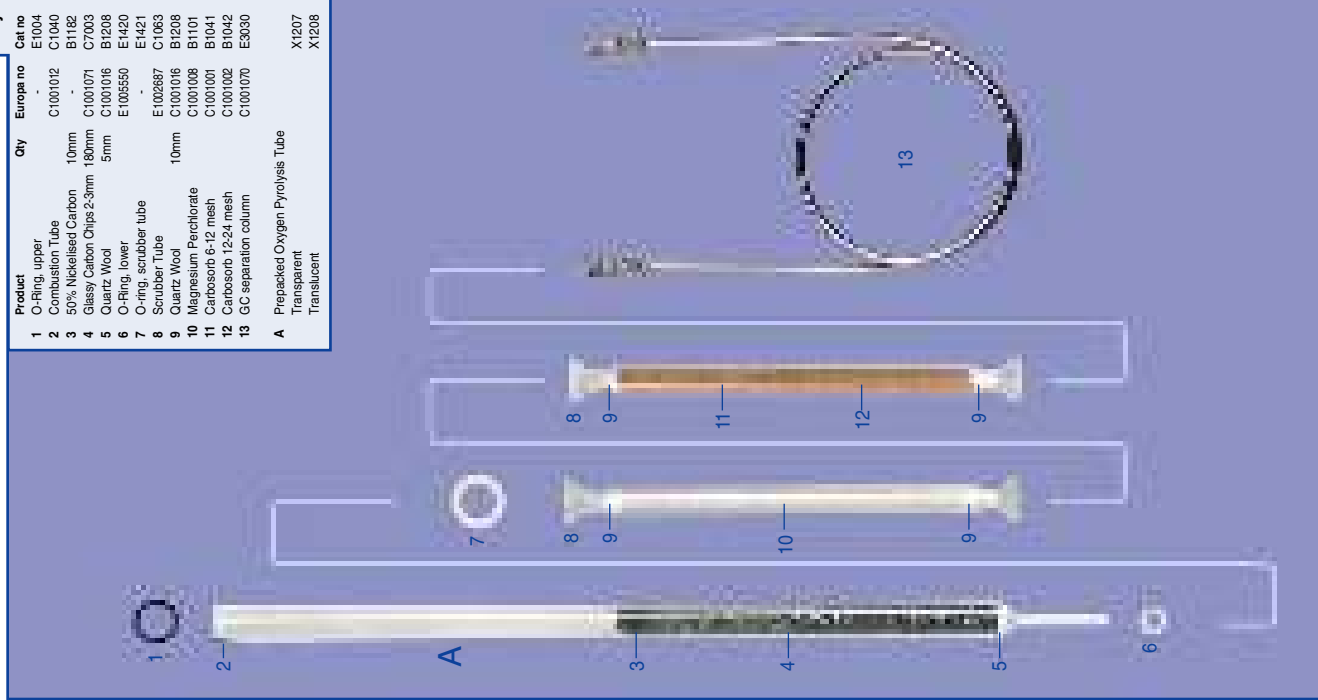

H PYROLYSIS

Key	
Product	Cat no
1 O-ring, upper	E1004
2 Combustion Tube	C1040
3 Glassy Carbon Chips 2.3mm	C7003
4 Quartz Wool	B1208
5 O-ring, lower	E1420
6 O-ring, scrubber tube	E1421
7 Scrubber Tube	E102887
8 Quartz Wool	C100106
9 Magnesium Perchlorate	B1208
10 Carbosorb 6-12 mesh	C1001001
11 Carbosorb 12-24 mesh	B1042
12 GC separation column	C1001070
A Prepared Hydrogen Pyrolysis Tube	E3030
Translucent	X1209
Prepacked	X1210

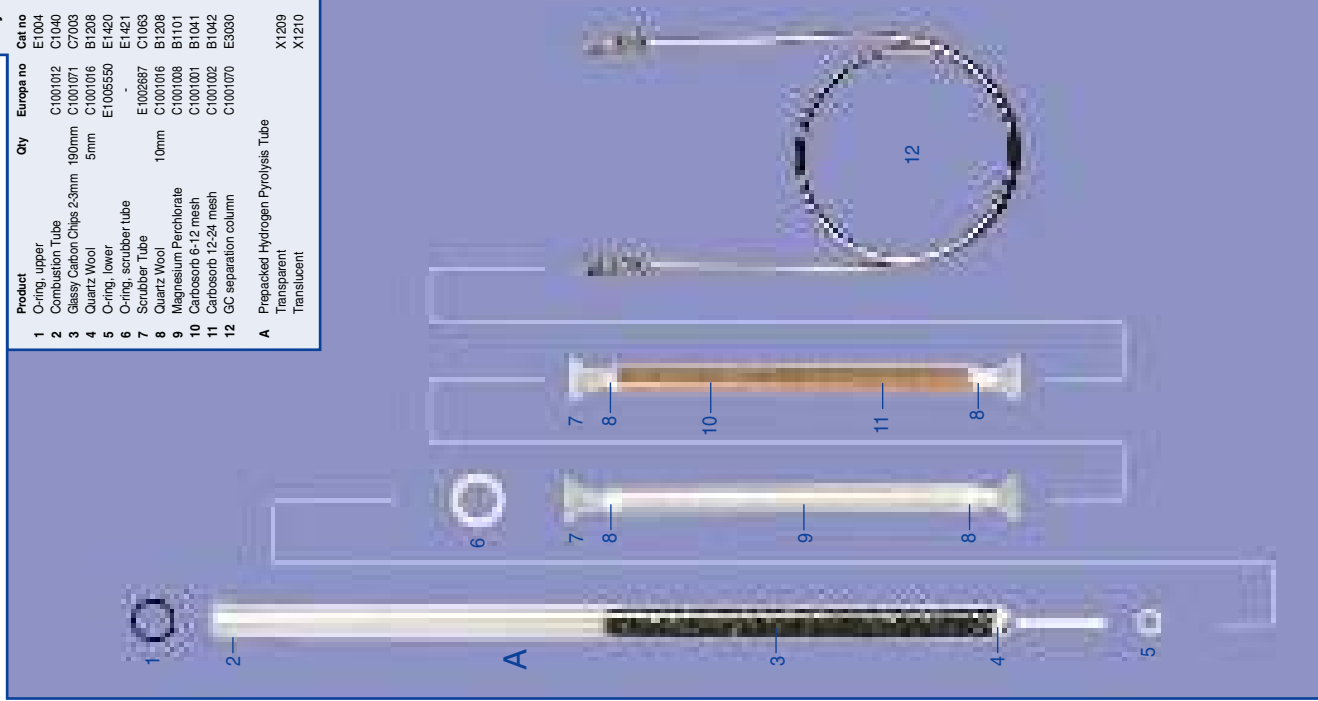

EUROPA ROBOPREP CN

Key	
Product	Cat no
1 O-ring, upper	E1004
2 Reaction tube	C1040
3 Quartz wool	B1208
4 Chromium oxide	B1004
5 Copper oxide wires	B1002
6 Silver wool	B1119
7 O-ring, lower	E108550
8 Reduction tube	C100104
9 Quartz wool	C100106
10 Copper wires	B1015
11 Scrubber tube	C100105
12 Magnesium perchlorate	C1001008
13 Carbosorb 6-12 mesh	B1101
14 Carbosorb 12-24 mesh	B1180
15 O-ring, scrubber tube	C1001001
16 GC separation column	B1042
A Prepared Reaction Tube (includes C1050 liner)	E1421
Translucent	E3033
Prepacked	X1200
Reduction Tube	X1201
Prepacked	X1202

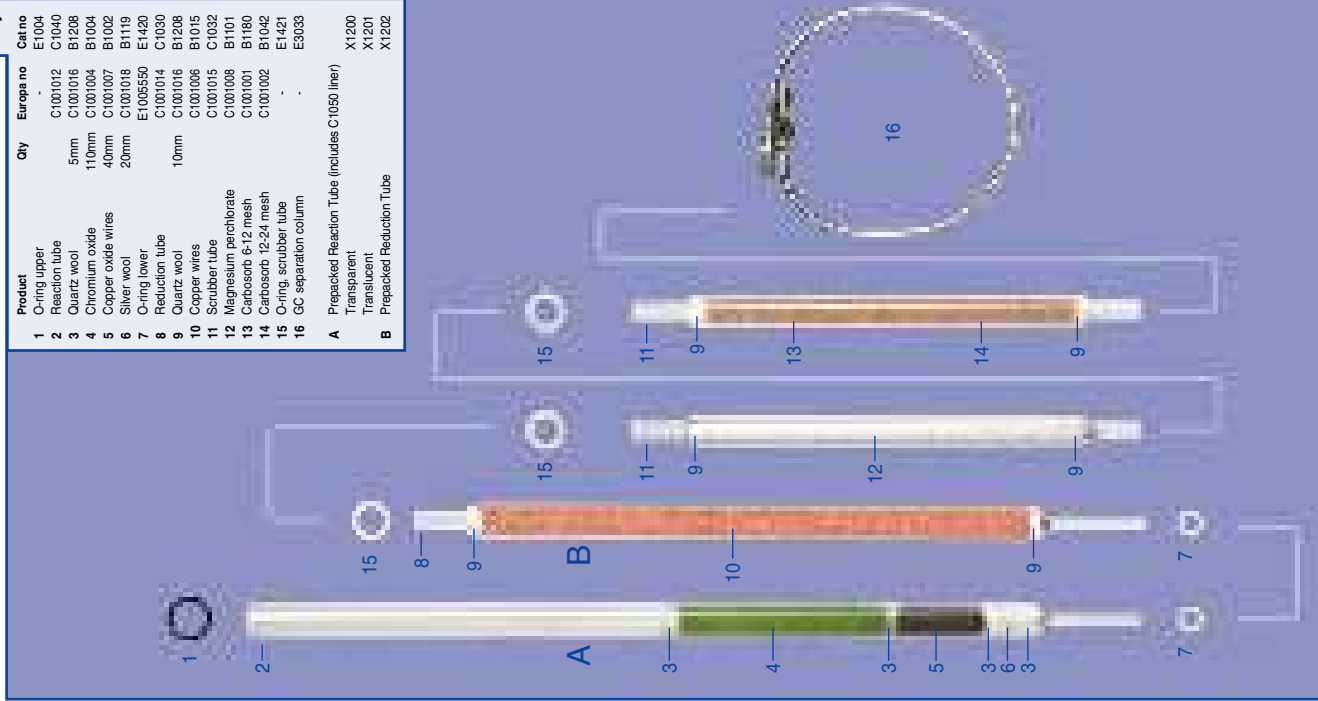

CN DETERMINATION

Key		Product	Qty	Costech no	Cat no
1	O-ring			61106	E1041
2	Tube, transparent			61104	C1022
3	Tube, translucent			61105	C1023
4	Quartz Wool		10mm	021035	B1206
5	Silvered Cobaltous/ic		110mm	011001	B1179
6	Quartz Wool		60mm	011007	B1000
7	Copper Wires		40mm	021035	B1208
8	Cap Kit			011013	B1015
	OR			071122/23	C1020
9	PTFE faced Seal			071122	E1021
10	Scrubber Tube			071120	C1008
11	MgClO ₄			021022	B1101
	Column		3m	051082	E3004
	Column		4m	051085	E3006
A	Prepacked Reaction Tube, transparent			06112	X1220
B	Prepacked Reaction Tube, translucent				X1221
	Prepacked Reduction Tube, transparent				X1222
	Prepacked Reduction Tube, translucent				X1223

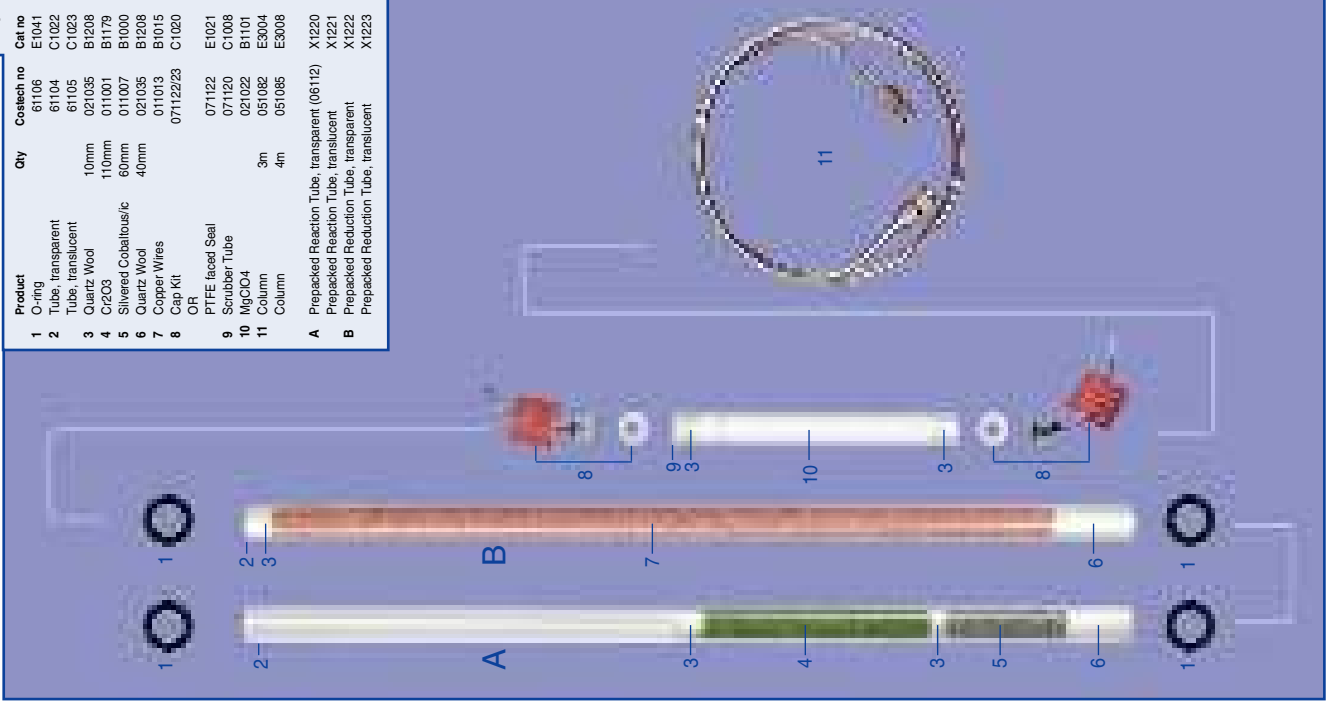

N DETERMINATION

Key		Product	Qty	Costech no	Cat no
1	O-ring			61106	E1041
2	Tube, transparent			61104	C1022
3	Tube, translucent			61105	C1023
4	Quartz Wool		10mm	021035	B1208
5	Cr2O3		110mm	011001	B1179
6	Silvered Cobaltous/ic		60mm	011007	B1000
7	Quartz Wool		40mm	021035	B1208
8	Copper Wires			011013	B1015
	OR			071122/23	C1020
9	PTFE faced Seal			071122	E1021
10	MgClO ₄			071120	C1008
11	Co Trap			021022	B1101
12	MgClO ₄		30mm	071121	C1014
13	Co Absorbent			021022	B1101
14	Column		3m	021020	B1100
	Column		4m	051082	E3004
	Column		4m	051085	E3008
A	Prepacked Reaction Tube, transparent				X1220
B	Prepacked Reaction Tube, translucent				X1221
	Prepacked Reduction Tube, transparent				X1222
	Prepacked Reduction Tube, translucent				X1223

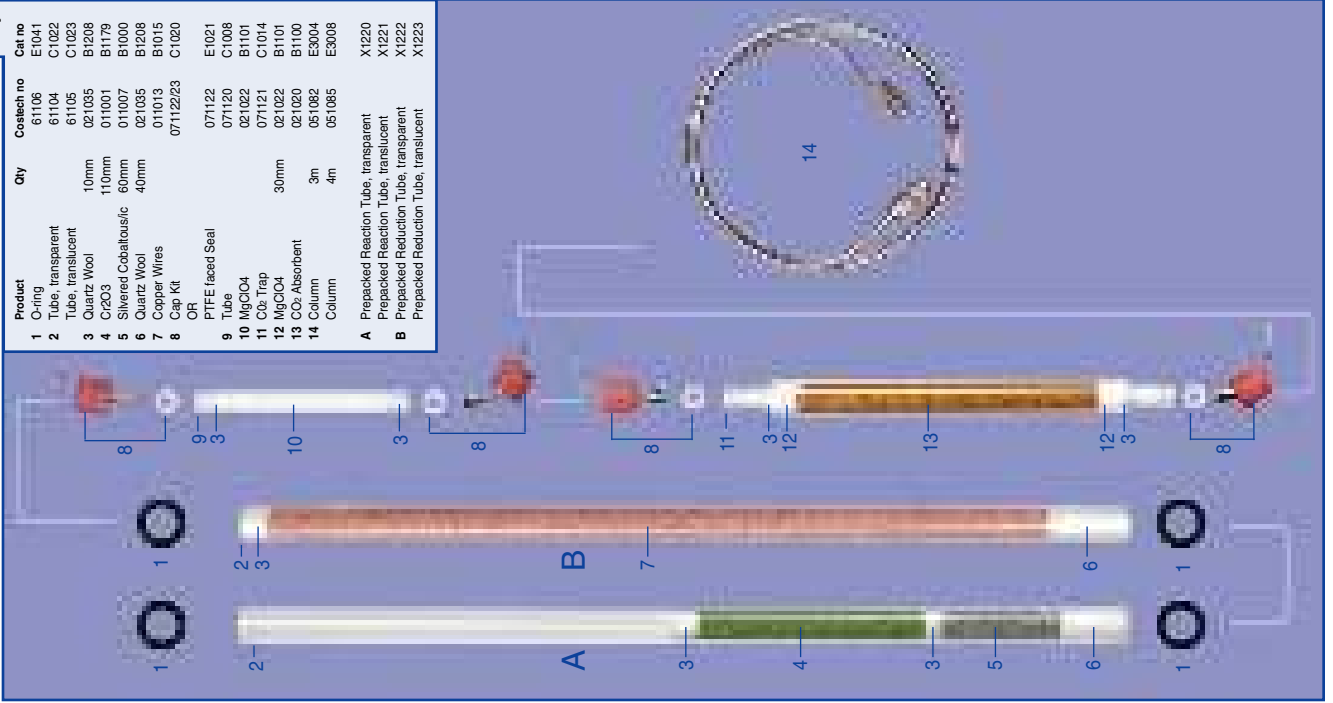

NCS/S DETERMINATION

Key		Product	Qty	Costech no	Cat no
1	O-ring			060016	E1041
2	Tube, transparent			061104	C1022
3	Tube, translucent			061105	C1023
4	Quartz Wool		10mm	021035	B1208
5	Tungstic Oxide		50mm	011008	B1025
6	Quartz Wool		20mm	021035	B1208
7	Copper Wire for S		110mm	011005	B1035
8	Quartz Wool		40mm	021035	B1208
	Cap Kit			071122/23	C1020
	OR				
9	PTFE faced Seal			071122	E1021
10	Tube			071120	C1008
11	MgClO ₄			021022	B1101
	Column, PTFE		0.8m	051083	E3002
	Column, SS		2m	051080	E3003
A	Prepacked Tube, transparent				X1224
	Prepacked Tube, translucent				X1225

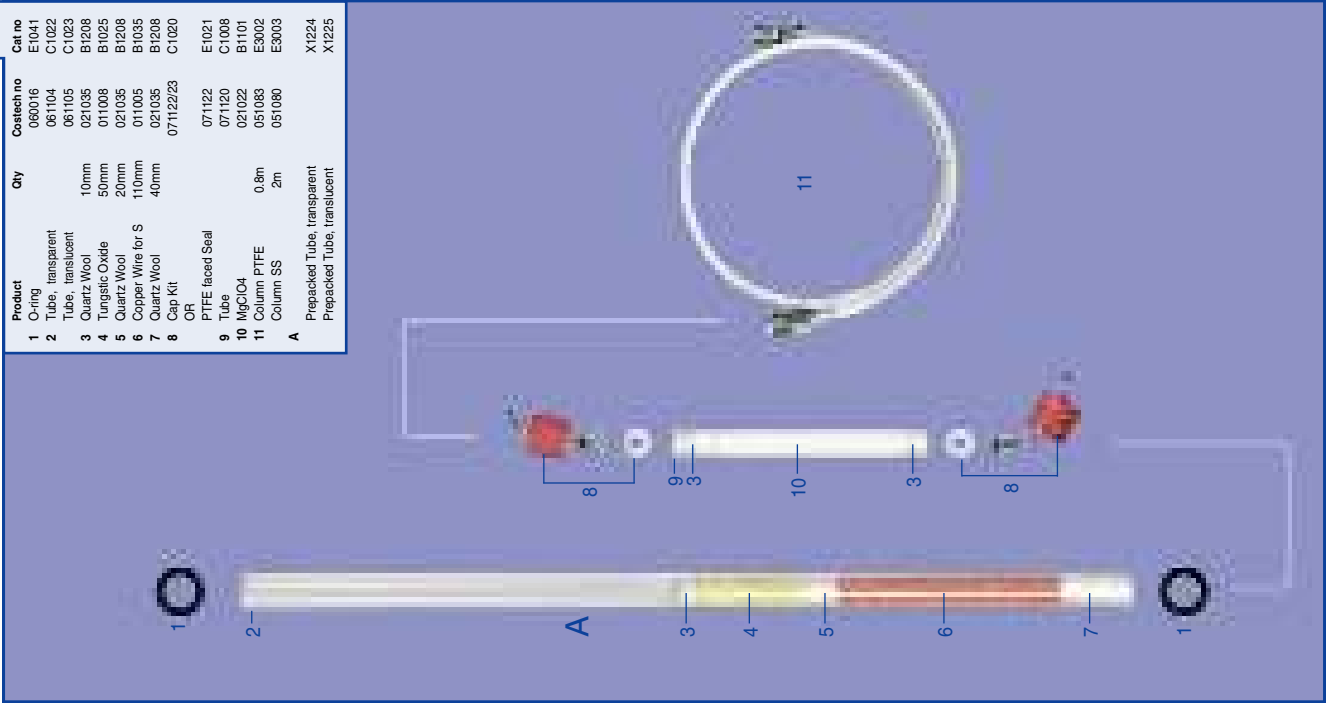

O PYROLYSIS

Key	
Product	Cat no
1 O-ring	E1041
2 Tube, clear	C1022
3 Nickel Wool	B1007
4 Nickelised Carbon Wool	B1242
5 Quartz Chips	B1008
6 Quartz Wool	B1208
7 Cap Kit	C1020
OR	
8 PTFE Faced Seal	E1021
9 CO ₂ Trap	071121
10 Quartz Wool	C1014
11 MgO/Al ₂ O ₃	B1208
12 CO ₂ Absorbent	B1101
Column	021022
Column	021020
Column	B1100
Column	E3001
Column	E3016
A Prepacked Oxygen Pyrolysis Tube, Transparent	X1227
Translucent	X1228

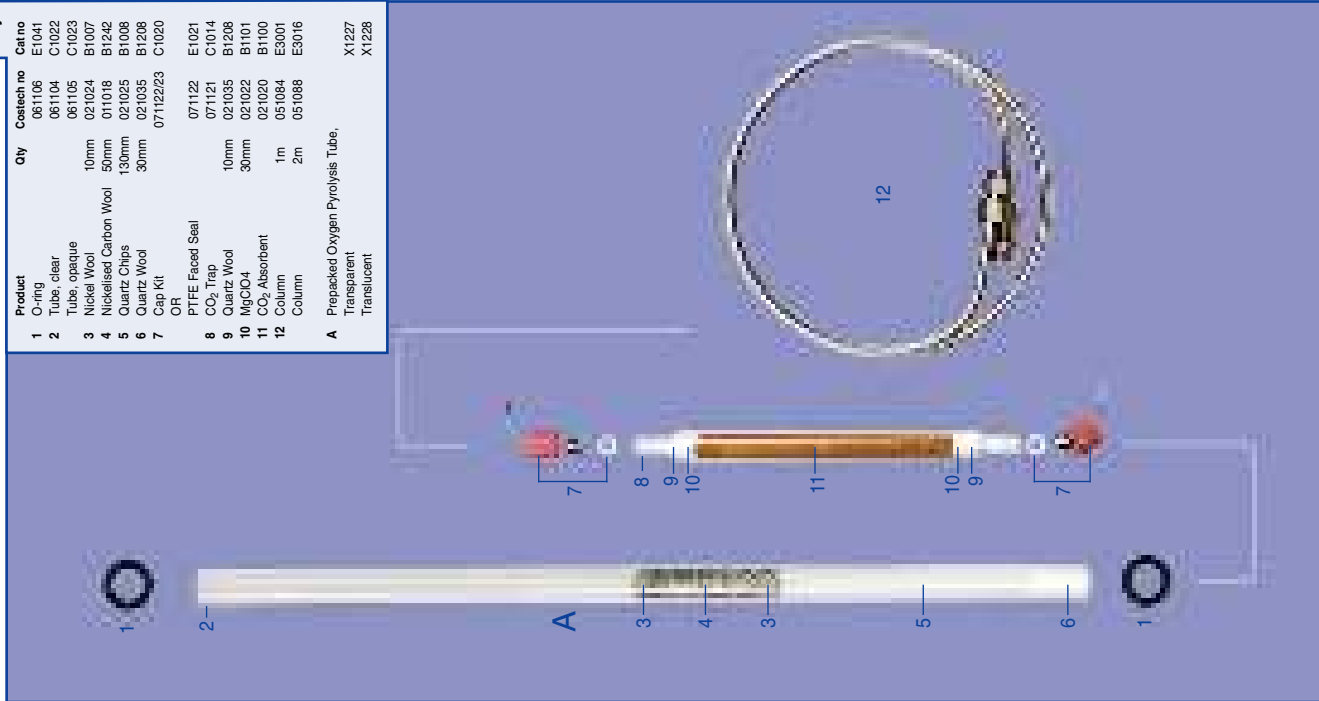

NCH DETERMINATION

Key	
Product	Cat no
1 O-ring	E1041
2 Tube, transparent	C1022
3 Quartz Wool	B1208
4 Cr2O3	B1179
5 Silvered Cobaltous/c	B1000
6 Quartz Wool	B1208
7 Copper Wires	B1015
8 Column	E3000
A Prepacked Reaction Tube, transparent (06112)	X1220
Prepacked Reaction Tube, translucent	X1221
B Prepacked Reduction Tube, transparent	X1222
Prepacked Reduction Tube, translucent	X1223

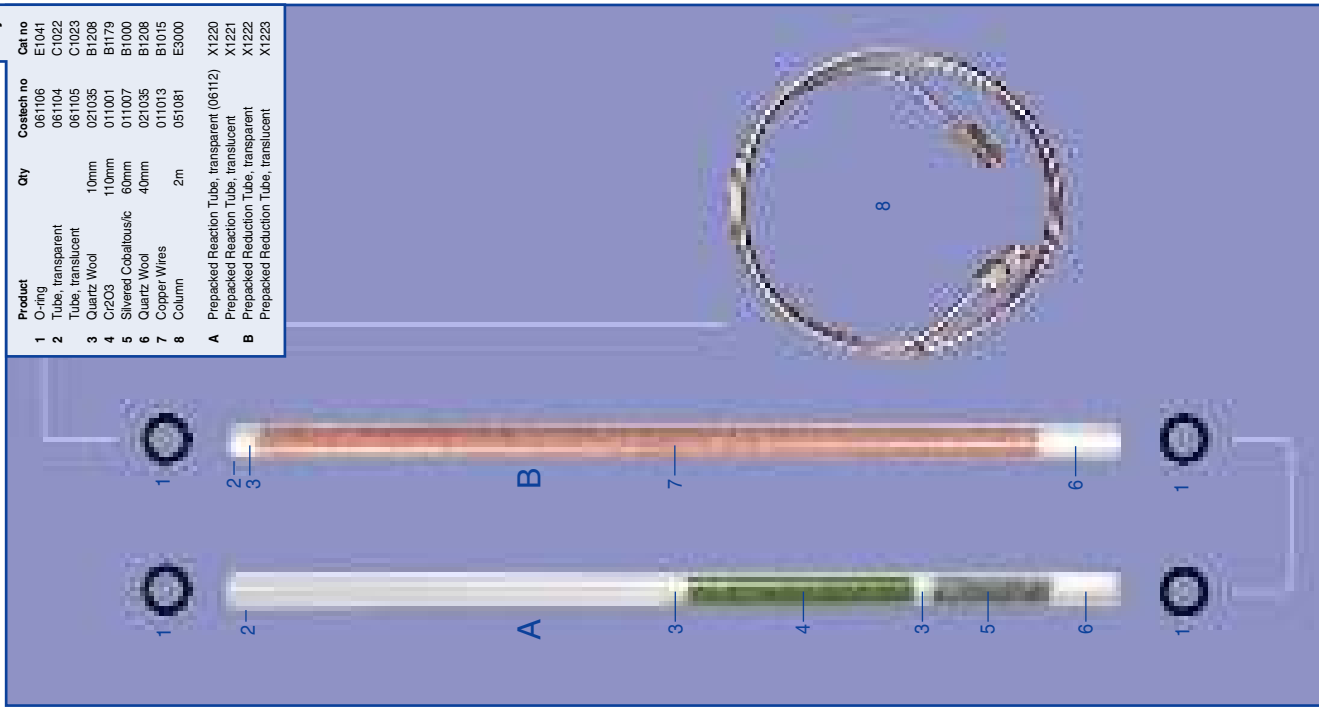

NCHS DETERMINATION

Key	
Product	Cat no
1 O-ring	E1041
2 Tube, transparent	C1022
3 Quartz Wool	B1208
4 Tungstic Oxide	B1025
5 Quartz Wool	B1208
6 Copper Wire br S	B1035
7 Quartz Wool	B1208
8 Column, PTFE	E3002
Column, SS	E3003
A Prepacked Tube, transparent	X1224
Prepacked Tube, translucent	X1225

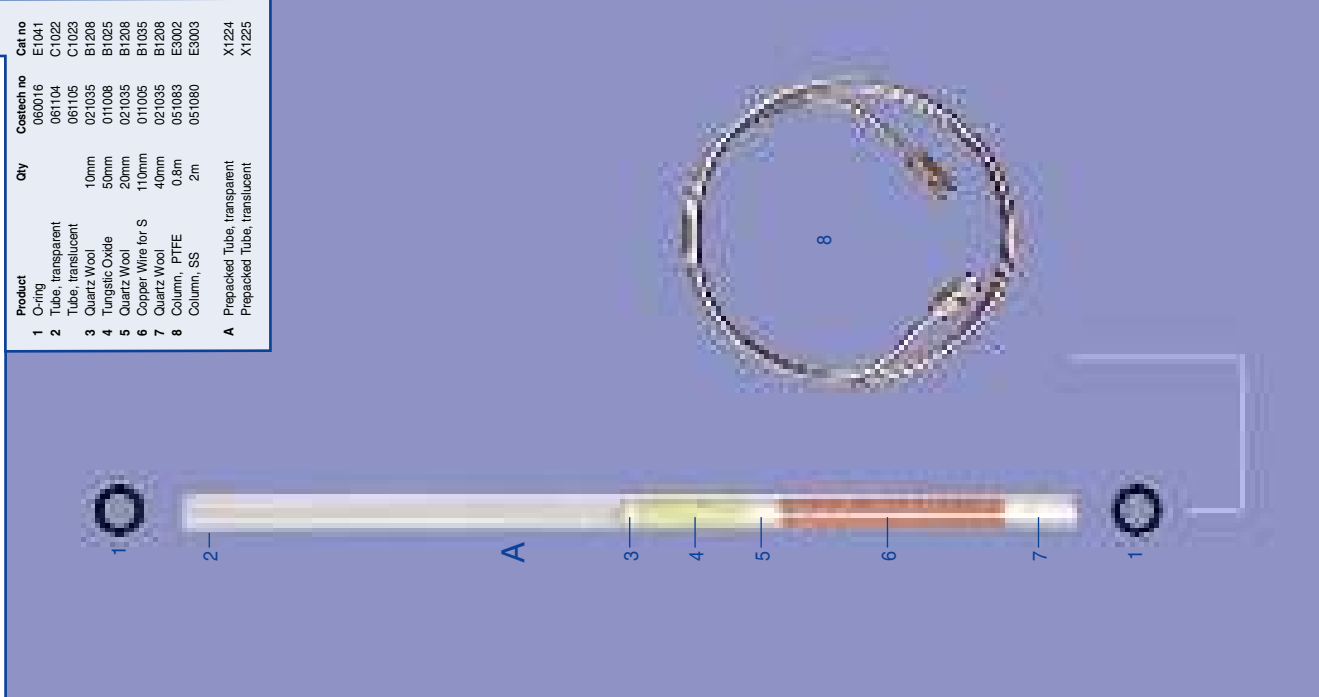

CHN DETERMINATION

		Key	
Product	Qty	CE no	Cat no
1 O-ring, chamfered		29032910	E1041
2 Tube, transparent		468 20001	C1022
3 Tube, opaque		468 20000	C1023
4 Cr2O3	10mm	33822200	B1017
5 Silvered Cobaltous/c	120mm	33822300	E1004
6 Quartz Wool	60mm	33824500	E1000
7 Bottom fitting	40mm	33822200	B1017
8 Copper Oxide Wires	34709512		
9 Copper Oxide Wires	50mm	33821710	B1002
10 Copper Grains	280mm	33835300	B1015
11 Quartz Wool	40mm	33822200	B1017
11 GC Column	26006200		E3000
A Prepacked Reaction Tube, transparent			X1041
B Prepacked Reaction Tube, translucent			X1015
B Prepacked Reduction Tube, transparent			X1040
B Prepacked Reduction Tube, translucent			X1016

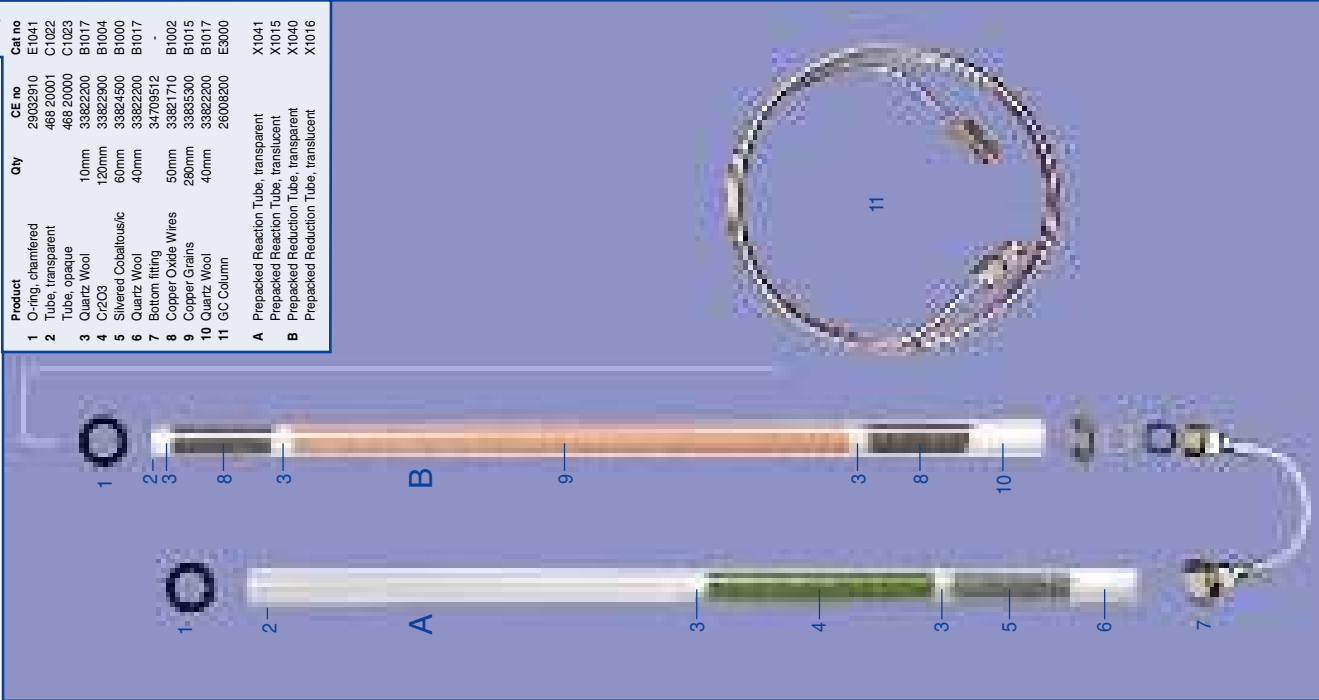

CHNS DETERMINATION

		Key	
Product	Qty	CE no	Cat no
1 O-ring, chamfered		290 32910	E1041
2 Tube, transparent		468 20001	C1022
3 Quartz Wool	10mm	338 22000	C1023
4 Tungstic Oxide	80mm	338 21600	B1025
5 Quartz Wool	338 22200		B1017
6 Copper Wires for CHNS	80mm	338 35310	B1035
7 Quartz Wool	40mm	338 22200	B1017
8 Bottom fitting		347 09518	-
9 GC Column		260 08206	E3003
A Prepacked Tube, transparent			X1046
A Prepacked Tube, translucent			X1012

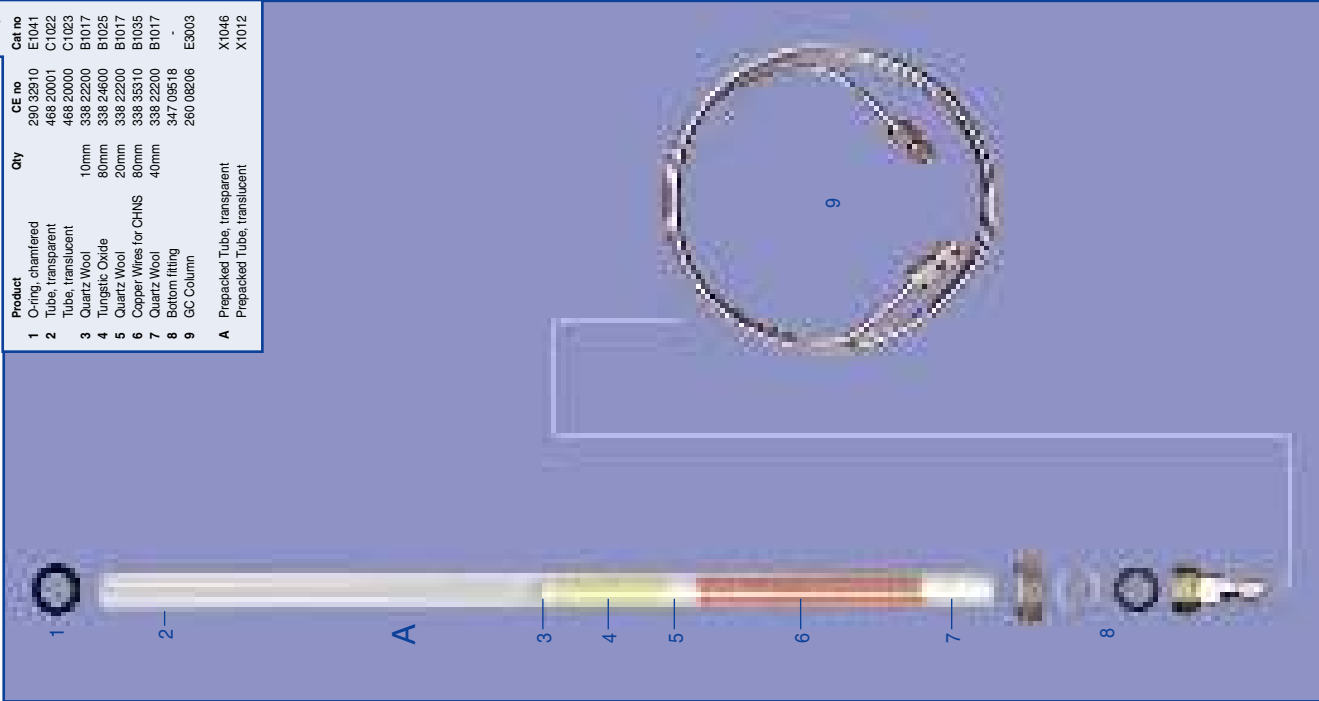

O DETERMINATION

		Key	
Product	Qty	CE no	Cat no
1 O-ring, chamfered		290 32910	E1041
2 Tube, clear		468 20001	C1022
3 Tube, opaque		468 20000	C1023
4 Nickel Wool	10mm	338 25000	B1007
5 Nickelised Carbon	50mm	338 23800	B1006
6 Quartz Chips	120mm	338 23000	B1008
7 Quartz Wool	40mm	338 22200	B1017
8 Bottom fitting		347 09518	-
8 Cap Kit			C1020
OR			
9 PTFE faced Seal			E1021
9 Quartz Wool	5mm	338 22200	B1017
10 Tube, threaded		261 13100	C1008
11 Ascarite		338 22000	B1018
12 MgClO4		338 21900	B1019
13 Column	1m	260 07900	E3001
A Prepacked Oxygen Pyrolysis Tube, transparent			X1047
A Prepacked Oxygen Pyrolysis Tube, translucent			X1021

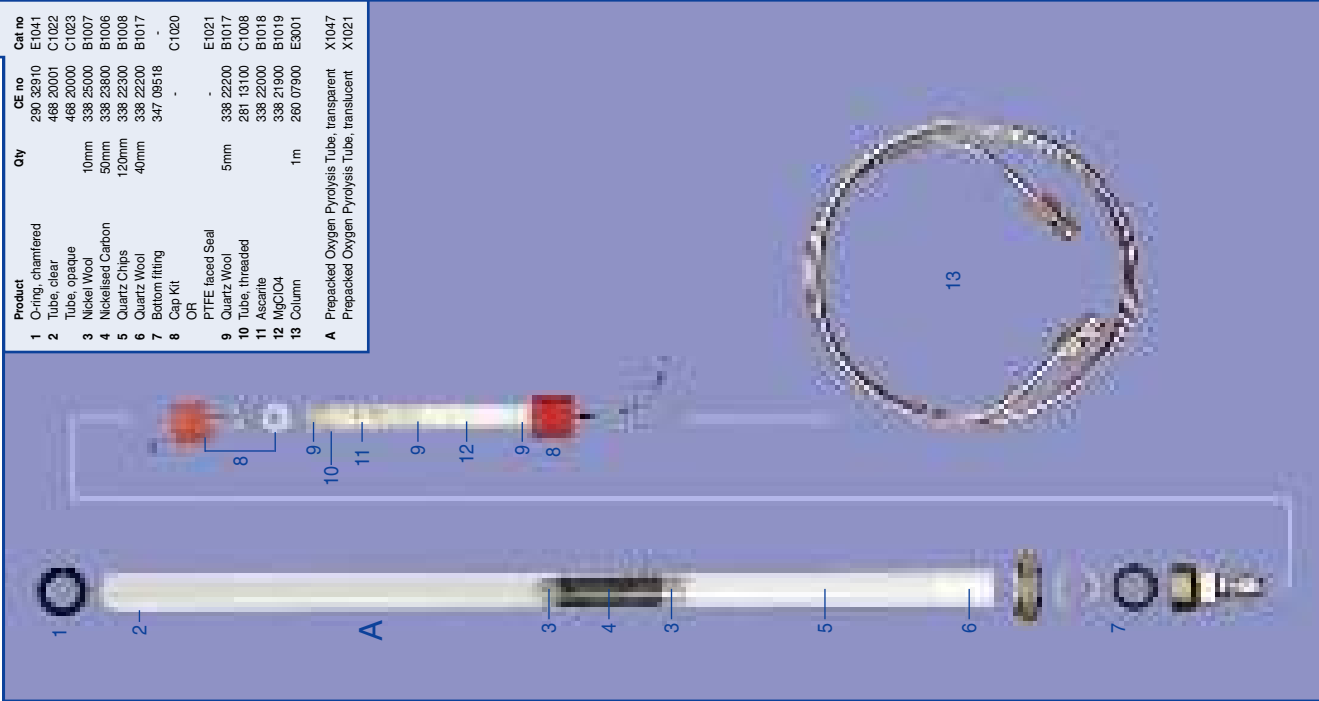

S DETERMINATION

Product	Qty	CE no	Cat no	Key
1 O-ring, chamfered		290 32910	E1041	
2 Tube, transparent		468 20001	C1022	
3 Quartz Wool	10mm	338 22200	B1017	
4 Tungstic Oxide	80mm	338 24600	B1025	
5 Quartz Wool	20mm	338 22200	B1017	
6 Copper Wires for CHNS	80mm	338 35310	B1035	
7 Quartz Wool	40mm	338 22200	B1017	
8 Bottom fitting		347 09518		
9 Cap Kit			C1020	
OR				
10 PTFE Faced Seal		281 13100	E1021	
11 Quartz Wool	5mm	338 22200	B1017	
12 MgClO ₄		338 21900	B1019	
13 GC Column		260 08206	E3003	
A Prepared Reaction Tube, transparent			X1046	
B Prepared Tube, translucent			X1012	

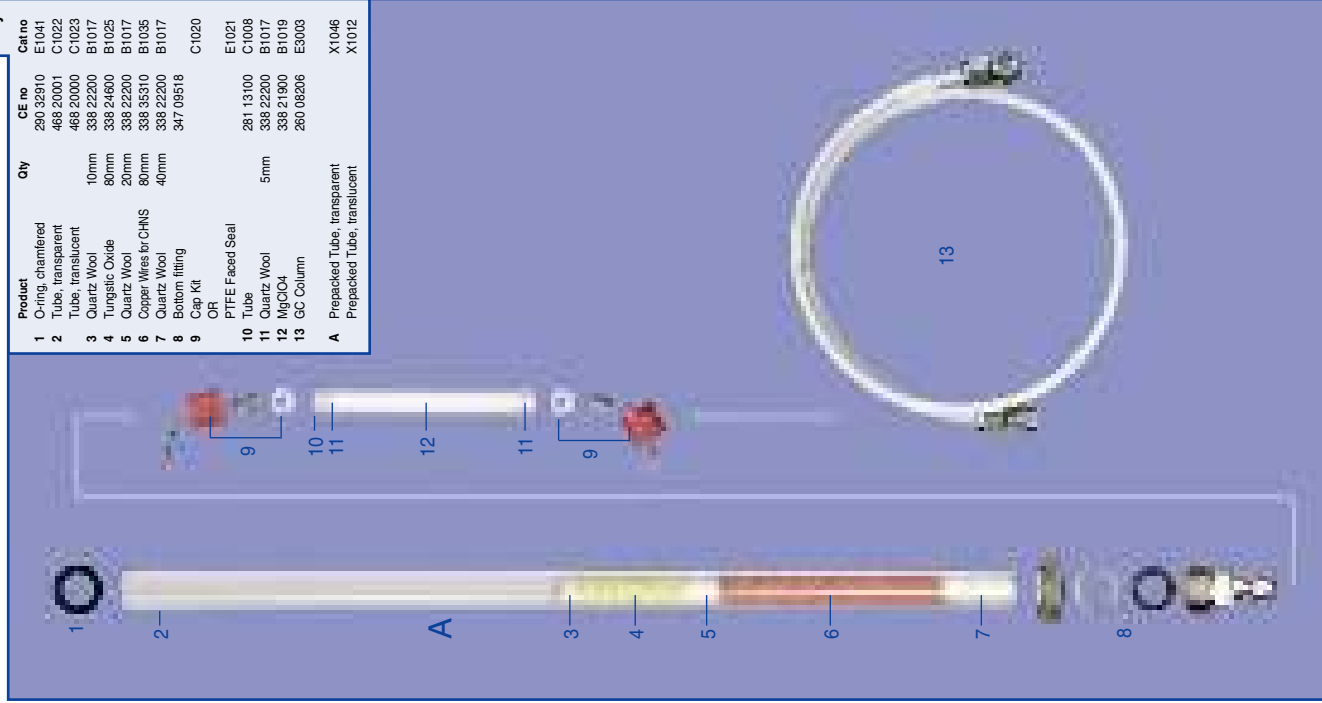

CHN DETERMINATION

Product	Qty	CE no	Cat no	Key
1 O-ring, chamfered		29032910	E1041	
2 Tube, clear		46820001	C1022	
3 Quartz Wool	10mm	33822200	B1017	
4 Cr2O3	120mm	33822900	B1004	
5 Silvered Cobaltous/ic	60mm	33824600	B1000	
6 Quartz Wool	40mm	33822200	B1017	
7 Bottom fitting		34709512		
8 Copper Oxide Wires	50mm	33821710	B1002	
9 Copper Grains	280mm	33835300	B1015	
10 Quartz Wool	40mm	33822200	B1017	
11 GC Column		26008200	E3000	
A Prepared Reaction Tube, transparent			X1041	
B Prepared Reaction Tube, translucent			X1015	
C Prepared Reduction Tube, transparent			X1040	
D Prepared Reduction Tube, translucent			X1016	

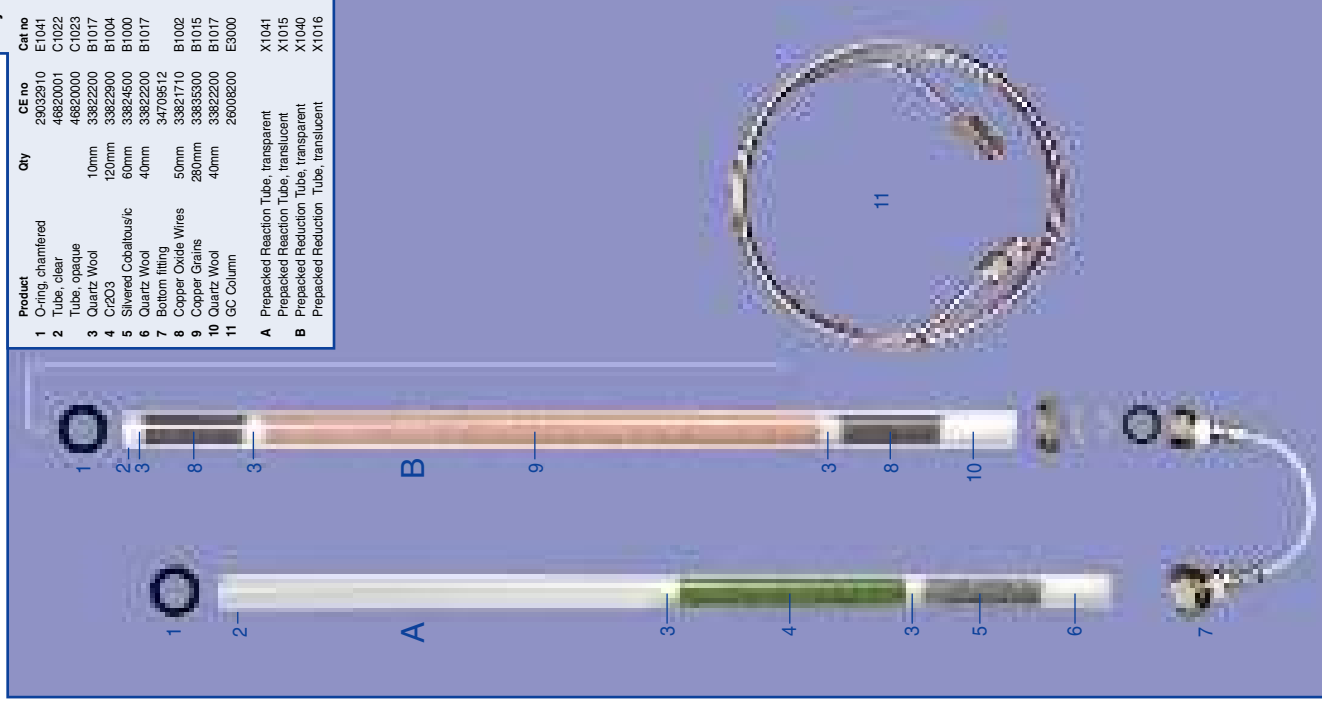

CHNS DETERMINATION

Product	Qty	CE no	Cat no	Key
1 O-ring		290 32910	E1041	
2 Tube, clear		468 20001	C1022	
3 Quartz Wool	5mm	338 22200	B1017	
4 WC3 Granular	60mm	338 24600	B1025	
5 Quartz Wool	20mm	338 22200	B1017	
6 Pure Copper	90mm	338 35310	B1035	
7 Quartz Wool	40mm	338 22200	B1017	
8 Bottom fitting		347 09518		
9 GC Column		260 08206	E3003	
A Prepared Reaction Tube, transparent			X1060	
B Prepared Reaction Tube, translucent			X1061	

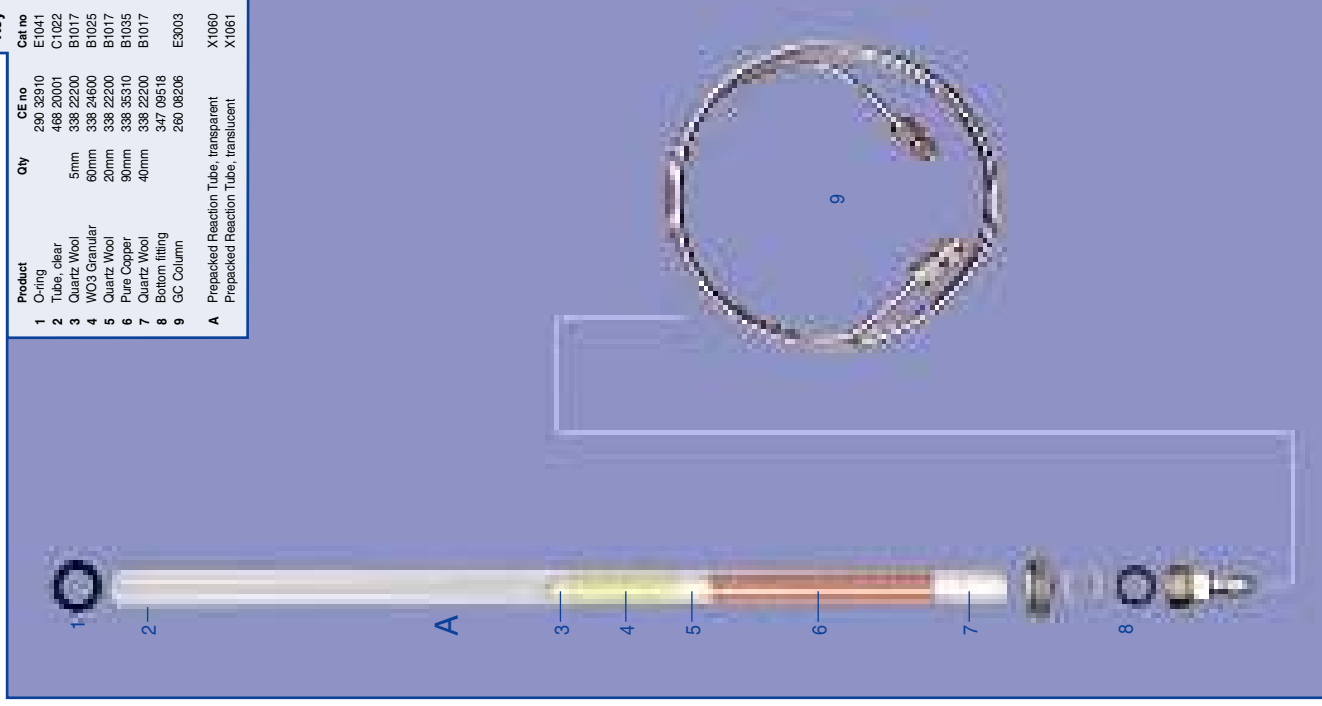

O DETERMINATION

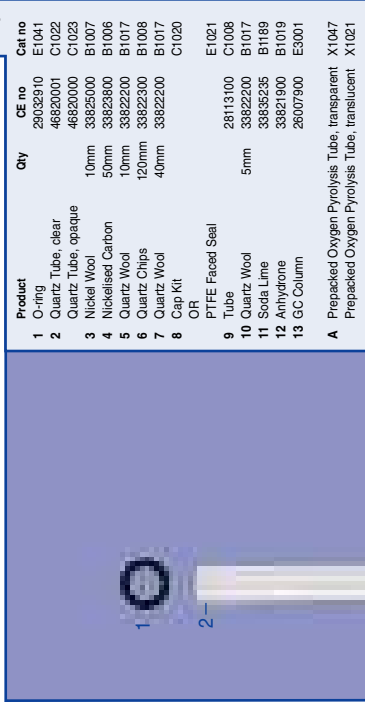

CHN DETERMINATION

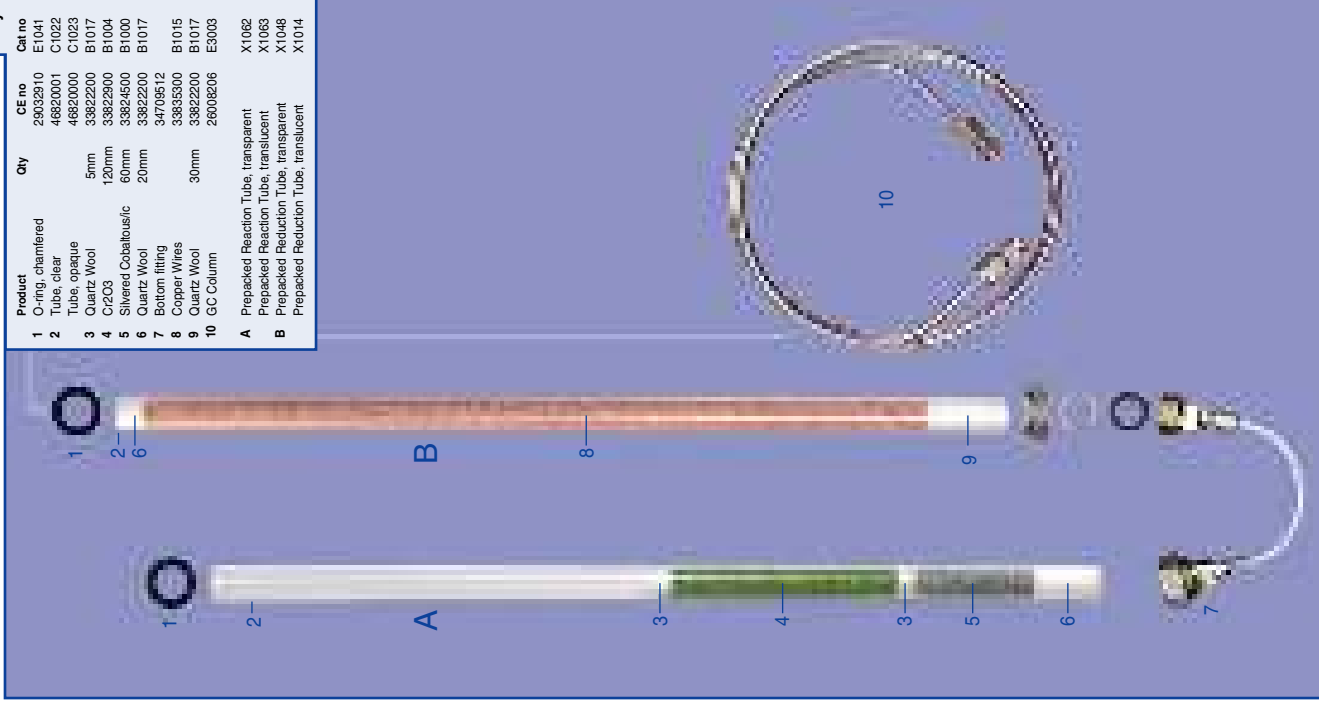

CN DETERMINATION

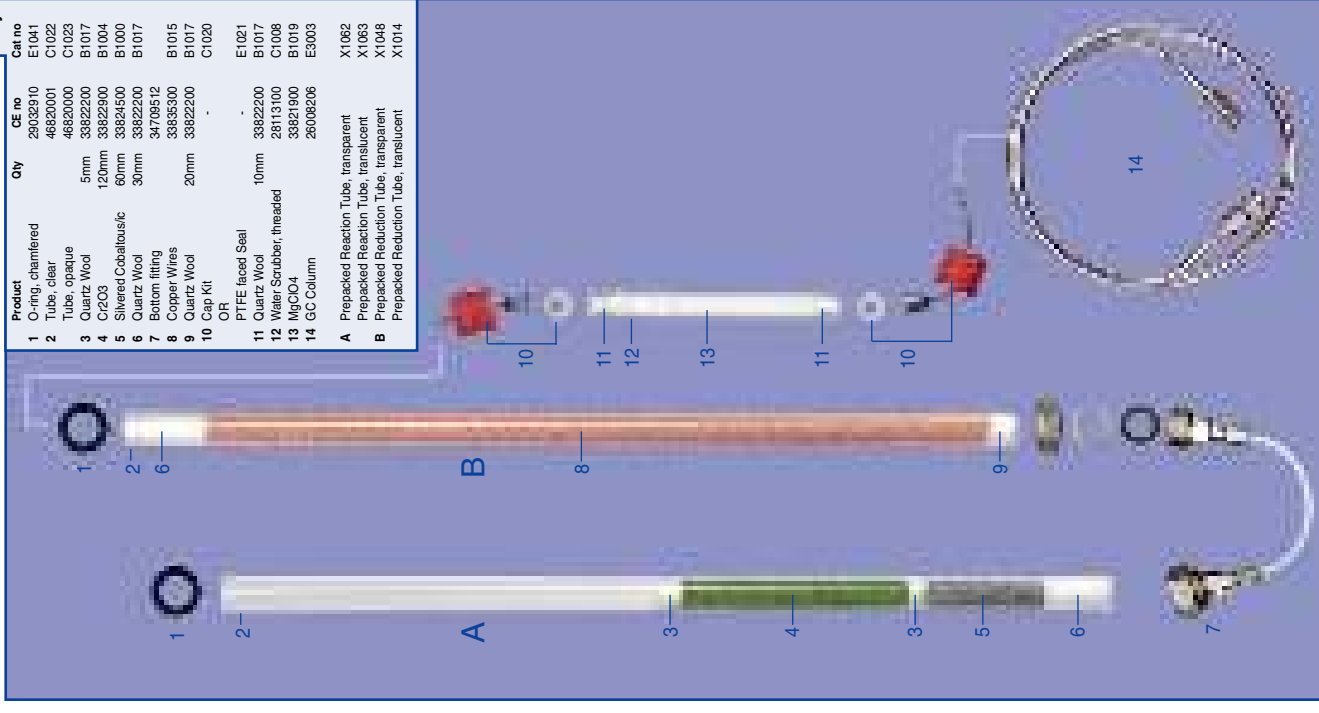

N DETERMINATION

Product	Qty	CE no	Cat no
1 O-ring, chamfered		29032910	E1041
2 Tube, clear		46820001	C1022
3 Quartz Wool	5 mm	46820000	C1023
4 Cr2O3	120 mm	33822500	B1017
5 Silvered Cobaltous/c	60 mm	33824500	B1004
6 Quartz Wool	20 mm	33822200	B1017
7 Bottom fitting	34705512		B1015
8 Copper Wires	33835300		B1017
9 Quartz Wool	33822500		B1015
10 Cap Kit			C1020
OR			
11 PTFE faced Seal			E1021
12 Quartz Wool	10 mm	33822200	B1017
13 Water Scrubber, threaded		28113100	C1008
14 Cd2 Scrubber, threaded		33821900	B1019
15 Molecular Sieve	50 mm	28113000	C1014
16 Ascarite/Mascorb/Carbosorb		33821900	B1021
17 GC Column		26008205	E3004
A Prepacked Reaction Tube, transparent			X1062
B Prepacked Reaction Tube, translucent			X1063
Prepacked Reduction Tube, transparent			X1048
Prepacked Reduction Tube, translucent			X1014

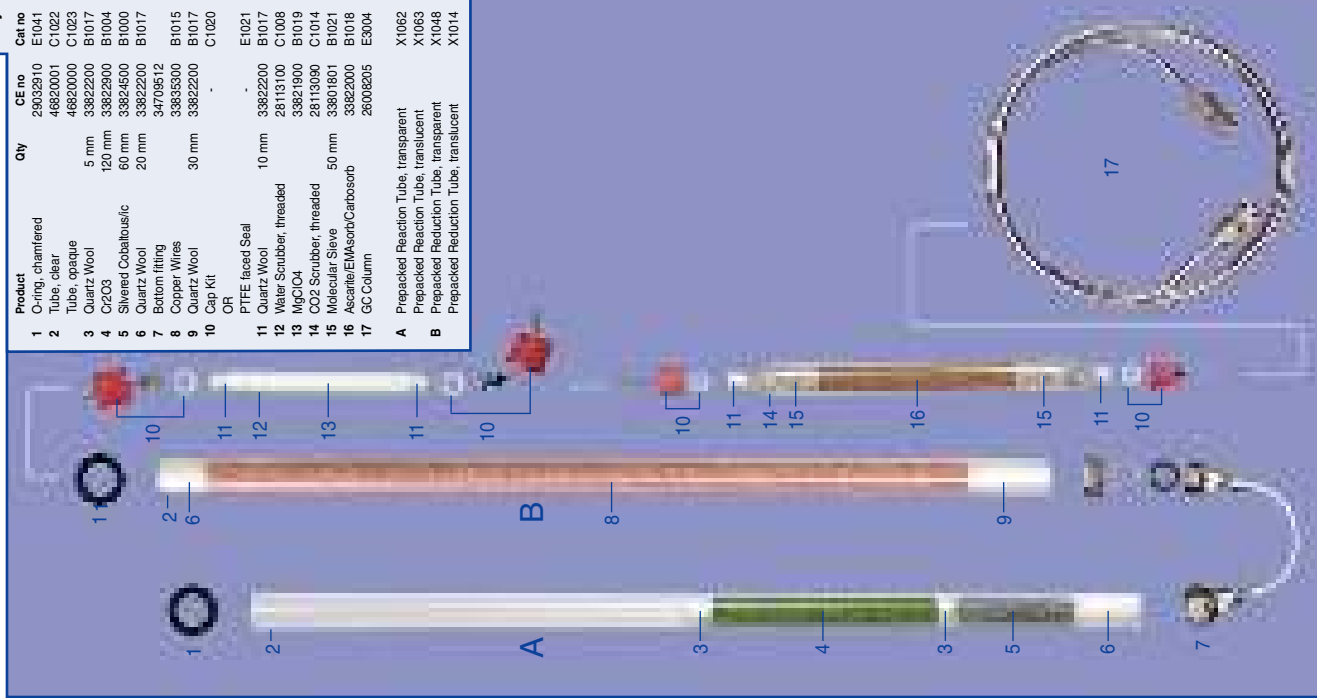

NCS DETERMINATION

Product	Qty	CE no	Cat no
1 O-ring, chamfered		29032910	E1041
2 Tube, clear		46820001	C1022
3 Quartz Wool	10mm	46820000	C1023
4 Tungstic Oxide	60mm	33821600	B1025
5 Quartz Wool	40mm	33822200	B1017
6 Copper Wires for S	100mm	33835310	B1035
7 Quartz Wool	30mm	33822200	B1017
8 Schott O-ring		29013603	E1021
OR			
9 Water Scrubber, threaded		28113100	C1008
10 MgClO4		33821900	B1019
11 GC Column		26008206	E3003
A Prepacked Reaction Tube, transparent			X1068
B Prepacked Reaction Tube, translucent			X1069

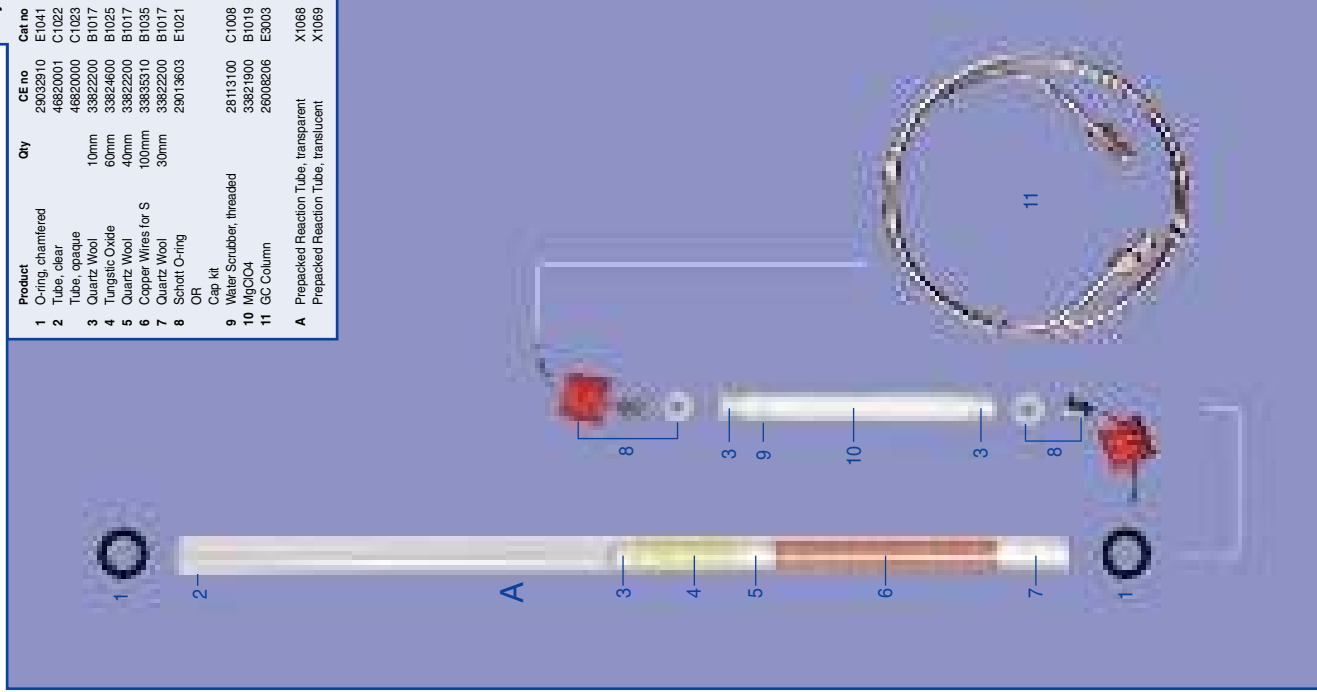

C + N DETERMINATION

Product	Qty	CE no	Cat no
1 O-ring, round		29030042	E1004
2 O-ring, chamfered		46801600	C1002
3 Quartz Wool	5 mm	33822200	B1017
4 Cr2O3	120 mm	33822500	B1004
5 Silvered Cobaltous/c	60 mm	33824500	B1000
6 Quartz Wool	10 mm	33822200	B1017
7 O-ring	29055567		E1000
8 Joint Coupling	34719475		-
9 Quartz Wool	20 mm	33822500	B1017
10 Copper Granules		33835300	B1013
(Could use wires B1015)			
11 Schott O-ring		29013603	E1021
OR Cap kit			
12 Scrubbing Tube, threaded		28113100	C1008
13 Molecular Sieves 3A		33801801	B1021
OR			
MgClO4		33821900	B1019
GC Column		26008206	E3003
A Prepacked Reaction Tube, transparent			X1064
B Prepacked Reaction Tube, translucent			X1065
Prepacked Reduction Tube, transparent			X1066
Prepacked Reduction Tube, translucent			X1067

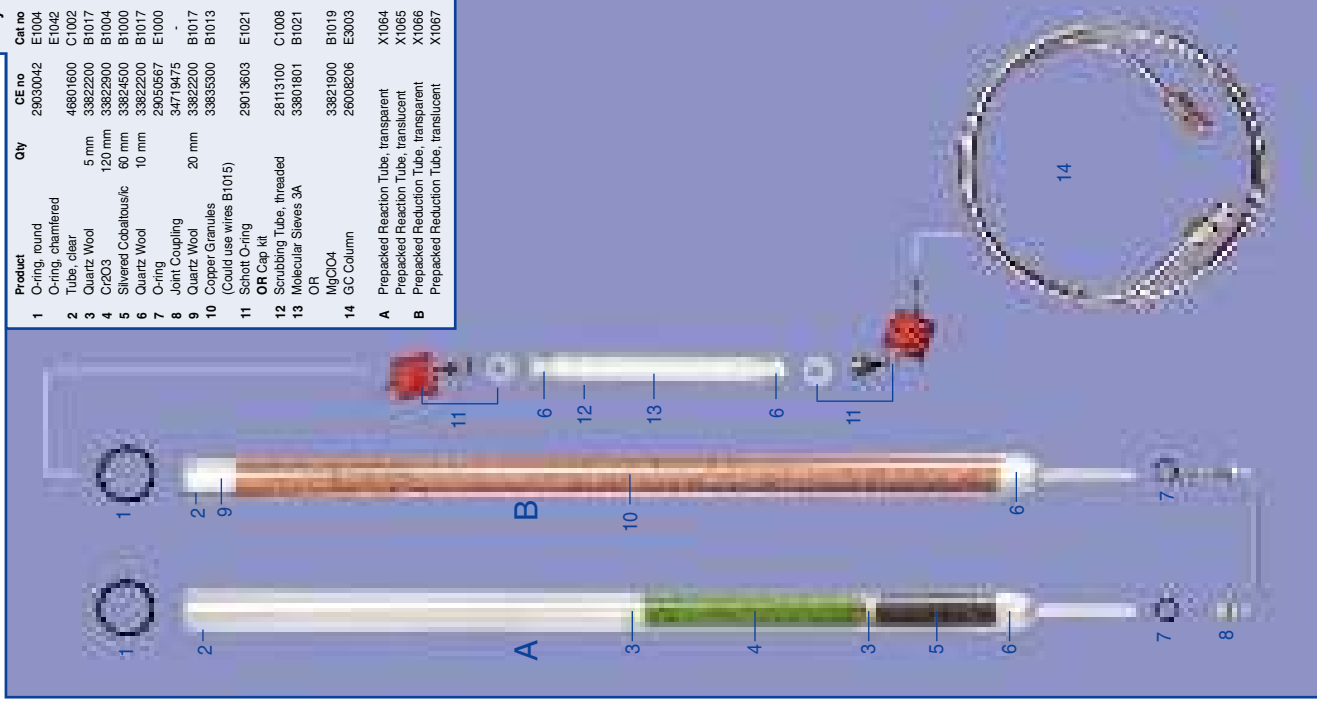

N DETERMINATION

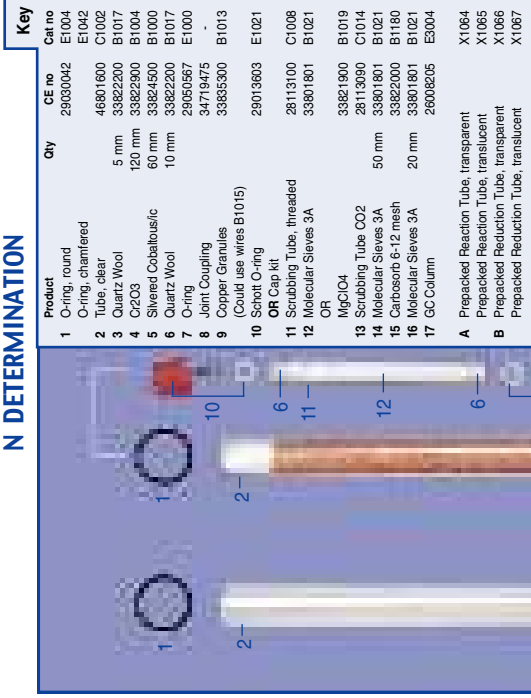

Product	Qty	CE no	Cat no	Key
1 O-ring, round		29030042	E1004	
2 Tube, clear		46801600	E1042	
3 Quartz Wool	5 mm	33822200	B1017	
4 Cr ₂ O ₃	120 mm	33822900	B1004	
5 Silvered Cobaltous/c	60 mm	33824500	B1000	
6 Quartz Wool	10 mm	33822200	B1017	
7 O-ring		29056557	E1000	
8 Joint Coupling		34719475	-	
9 Copper Granules		33835300	B1013	
10 Schott O-ring		29013603	E1021	
11 Scrubbing Tube, threaded		28113100	C1008	
OR Cap kit		33801801	B1021	
12 Molecular Sieves 3A		33821900	B1019	
OR MFC/O ₂		28119090	C1014	
13 Scrubbing Tube CO ₂		33801801	B1021	
14 Molecular Sieves 3A	50 mm	33822000	B1180	
15 Carosorb 6-12 mesh		33801801	B1021	
16 Molecular Sieves 3A	20 mm	26008205	E3004	
17 GC Column				
A Prepacked Reaction Tube, transparent			X1064	
B Prepacked Reaction Tube, translucent			X1065	
Prepacked Reduction Tube, transparent			X1066	
Prepacked Reduction Tube, translucent			X1067	

N DETERMINATION

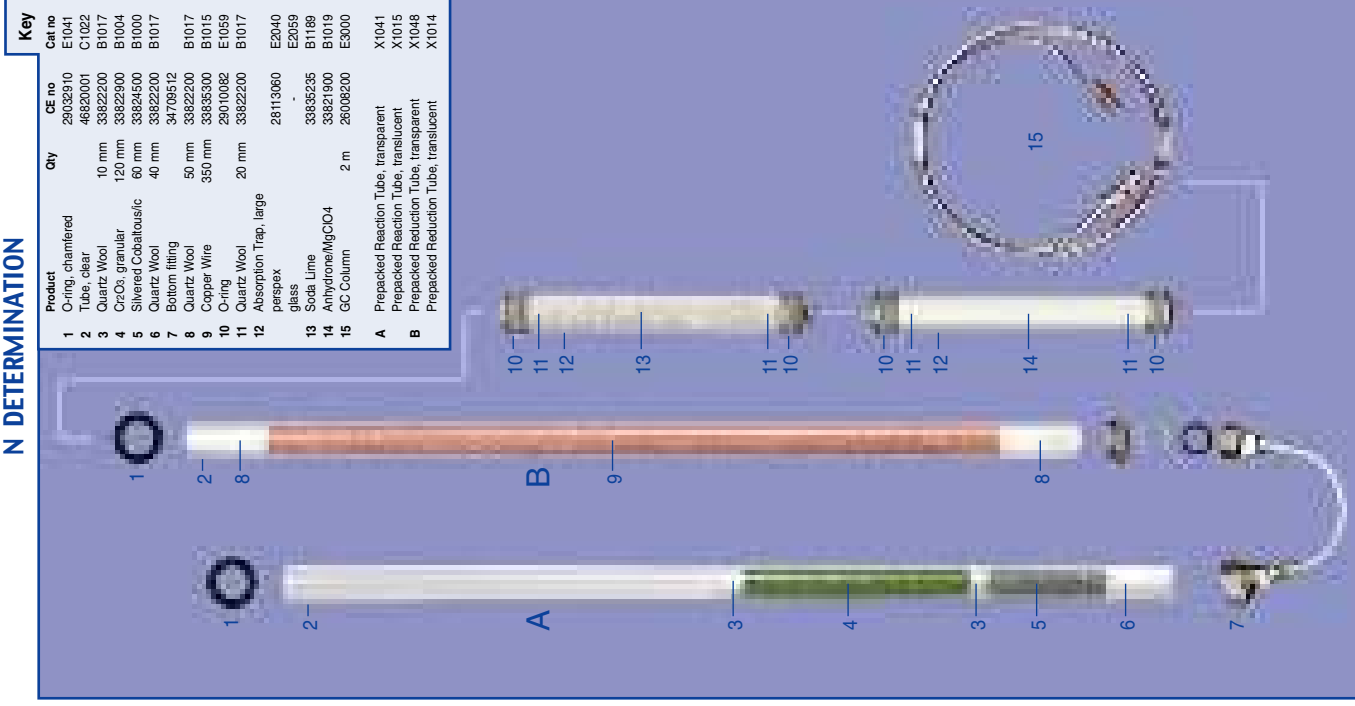

Product	Qty	CE no	Cat no	Key
1 O-ring, chamfered		29032910	E1041	
2 Tube, clear		46820001	C1022	
3 Quartz Wool	10 mm	33822200	B1017	
4 Cr ₂ O ₃ , granular	120 mm	33822900	B1004	
5 Silvered Cobaltous/c	60 mm	33824500	B1000	
6 Quartz Wool	40 mm	33822200	B1017	
7 Bottom fitting		34709512	-	
8 Quartz Wool	50 mm	33822200	B1017	
9 Copper Wire	350 mm	33835300	B1015	
10 Schott O-ring		29010082	E1059	
11 Quartz Wool	20 mm	33822200	B1017	
12 Absorption Trap, large perspex		28113060	E2040	
13 Soda Lime		33835235	E2059	
14 Anhydrous MgClO ₄		33821900	B1189	
15 GC Column	2 m	26008200	E3000	
A Prepacked Reaction Tube, transparent			X1041	
B Prepacked Reaction Tube, translucent			X1015	
Prepacked Reduction Tube, transparent			X1048	
Prepacked Reduction Tube, translucent			X1014	

NC DETERMINATION

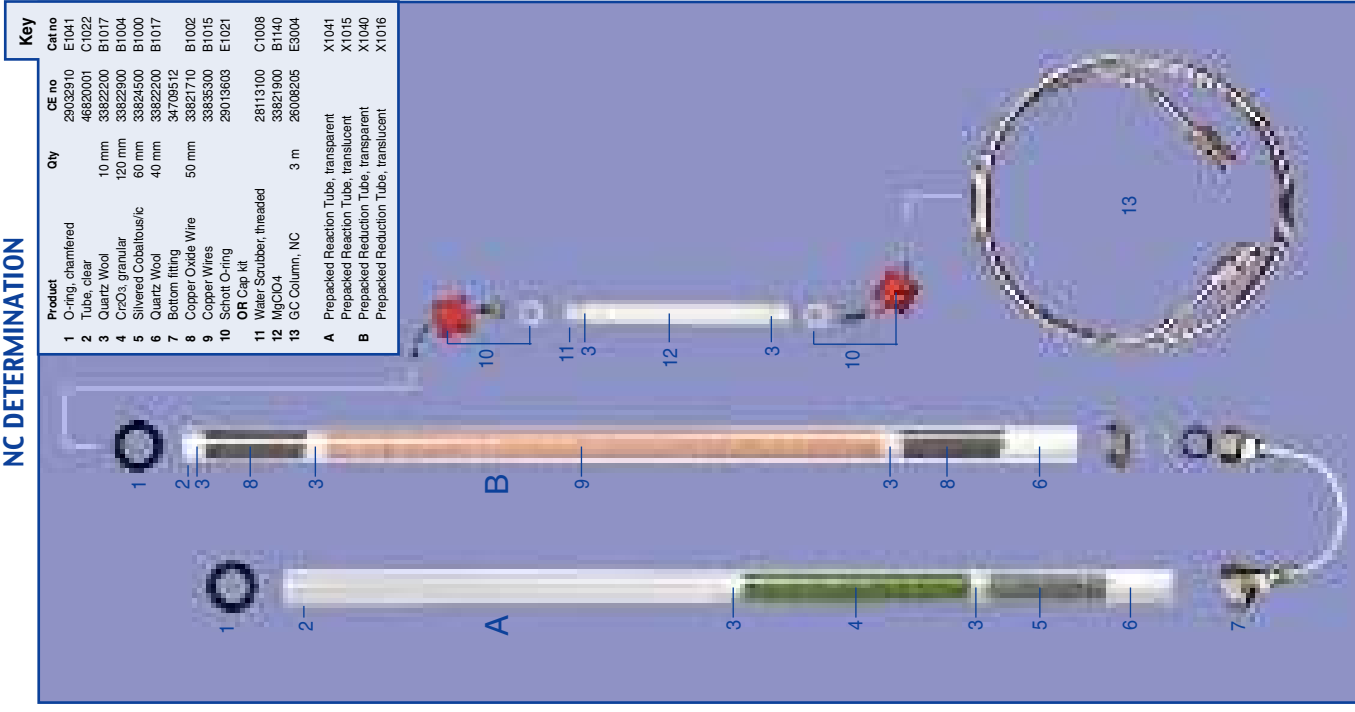

Product	Qty	CE no	Cat no	Key
1 O-ring, chamfered		29032910	E1041	
2 Tube, clear		46820001	C1022	
3 Quartz Wool	10 mm	33822200	B1017	
4 Cr ₂ O ₃ , granular	120 mm	33822900	B1004	
5 Silvered Cobaltous/c	60 mm	33824500	B1000	
6 Quartz Wool	40 mm	33822200	B1017	
7 Bottom fitting		34709512	-	
8 Copper Oxide Wire	50 mm	33821710	B1002	
9 Copper Wires		33835300	B1015	
10 Schott O-ring		29013603	E1021	
OR Cap kit				
11 Water Scrubber, threaded		28113100	C1008	
12 MgClO ₄		33821900	B1140	
13 GC Column, NC	3 m	26008205	E3004	
A Prepacked Reaction Tube, transparent			X1041	
B Prepacked Reaction Tube, translucent			X1015	
Prepacked Reduction Tube, transparent			X1040	
Prepacked Reduction Tube, translucent			X1016	

NCS DETERMINATION

Product		Qty	CE no	Cat no
1	O-ring		29032910	E1041
2	Quartz Tube, clear		46820001	C1022
3	Quartz Wool	5 mm	33822200	B1017
4	Tungstic Oxide, granular	60 mm	33824600	B1025
5	Quartz Wool	20 mm	33822200	B1017
6	Copper, high purity	100 mm	33835310	B1035
7	Quartz Wool	40 mm	33822200	B1017
8	Seal/O-ring		29013603	E1021
9	OR Cap kit		29013603	E1021
10	Quartz Wool	10 mm	33822200	B1017
11	Water Scrubber, threaded		28113100	C1008
12	MgClO ₄		33821900	B1140
	GC Column/NCS	2 m	26006206	E3003
A	Prepacked Reaction Tube, transparent			X1068
	Prepacked Reaction Tube, translucent			X1069

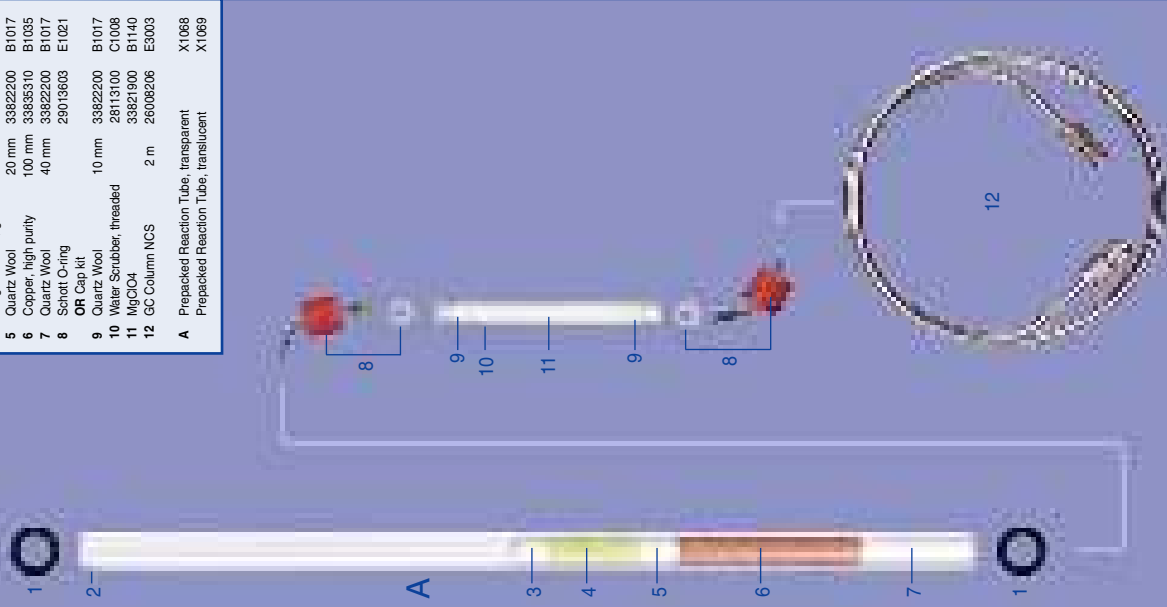

CHN DETERMINATION

Product		Qty	CE no	Cat no
1	O-ring, upper, round		29050306	E1002
2	O-ring, upper, chamfered		29050306	E1043
3	Reaction Tube, quartz		46800900	C1000
4	Reaction Tube, stainless steel			E2137
5	Quartz Wool	5 mm	33822200	B1017
6	CrO ₃	110 mm	33822900	B1004
7	Silvered Cobaltous/c	45 mm	33822900	B1001
8	O-ring, lower		29050567	E1000
9	Reduction U Tube, quartz		46801000	C1003
10	Reduction U Tube, stainless steel		39103900	E2020
11	Copper Wires		33835300	B1015
12	Copper Wires + Quartz Chips (S1)		33822900	B1008
13	Quartz Wool	10 mm	33822200	B1017
14	Copper Oxide Wires	50 mm	33821710	B1002
15	O-ring, reduction tube		29030031	E1001
16	GC Column CHN			E3000
A	Prepacked Reaction Tube			X1017
B	Prepacked Reaction Tube			X1018

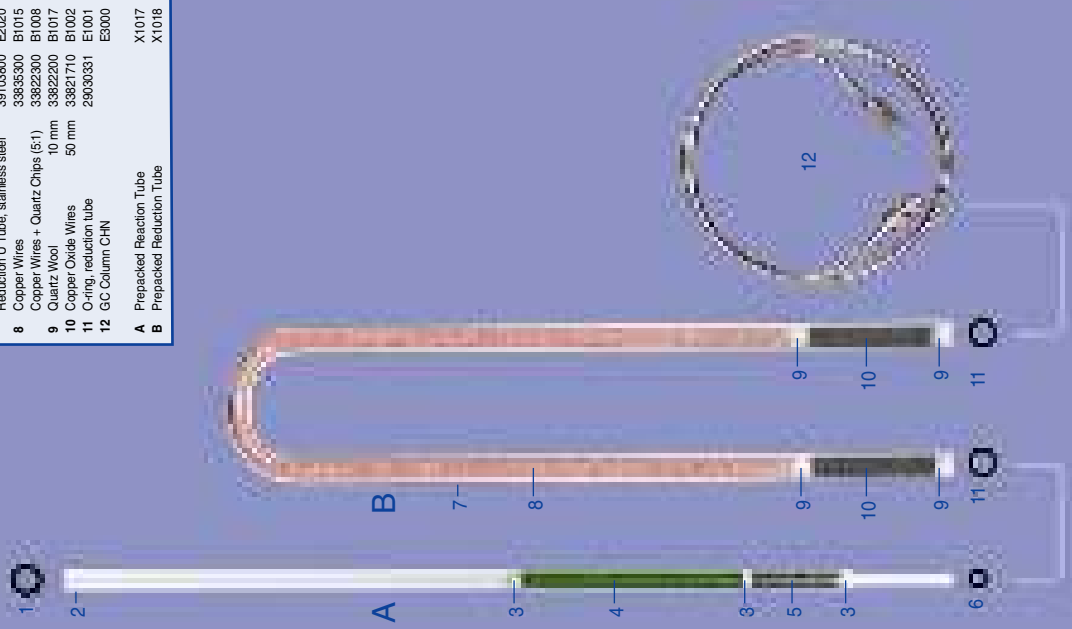

S DETERMINATION

Product		Qty	CE no	Cat no
1	O-ring, upper, round		29050306	E1002
2	O-ring, upper, chamfered		29050306	E1043
3	Tube, quartz		46800900	C1000
4	Tube, stainless			E2137
5	Quartz Wool	5 mm	33822200	B1017
6	Tungstic Oxide	85 mm	33824600	B1025
7	Copper Oxide Wires	15 mm	33821710	B1002
8	Copper, high purity	60 mm	33835310	B1035
9	O-ring, lower		29050567	E1000
10	Tube, plain		28104400	C1021
11	Tube, threaded		28113100	C1008
12	MgClO ₄		33821900	B1140
13	GC Column		26007800	E3002
A	Prepacked Reaction Tube, transparent			X1019

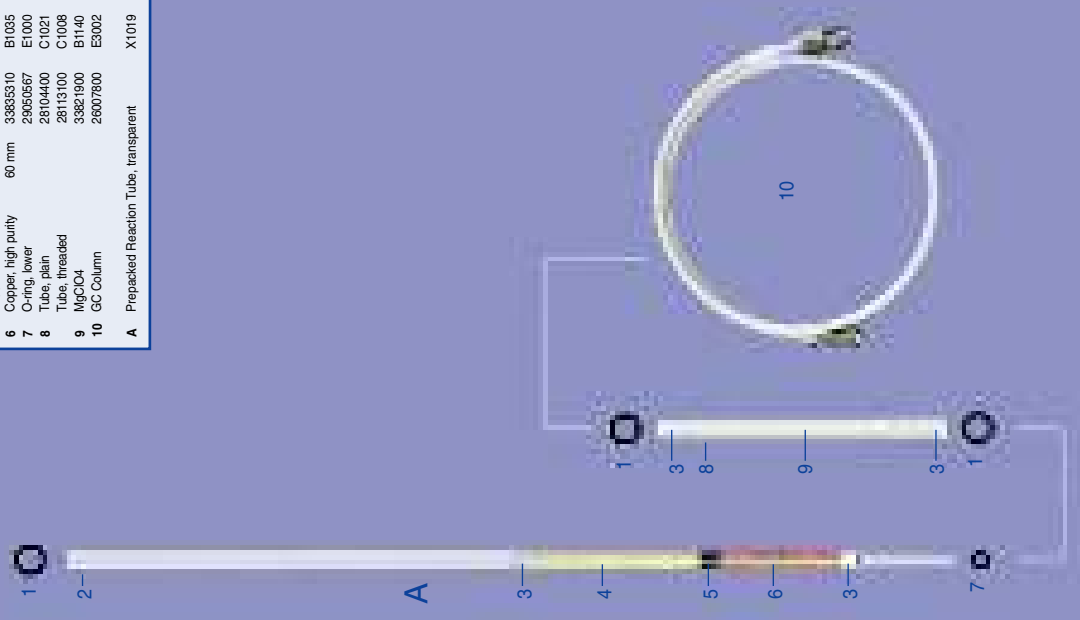

O DETERMINATION

		Key	
Product	Qty	CE no	Cat no
1 O-ring, round		29050306	E1002
2 O-ring, chamfered		29050306	E1043
3 Tube, quartz		46800900	C1000
4 Nickel Wool	10 mm	33825000	B1007
5 Nickelised Carbon 20%	80 mm	33823800	B1006
6 Nickel Wool	5 mm	33825000	B1007
7 Quartz Chips	80 mm	33822300	B1008
8 Quartz Wool	5 mm	33822300	B1017
9 O-ring, lower		29050567	E1000
10 Tube, plain	28104400	C1021	
11 Tube, threaded	28113100	C1008	
12 MgClO ₄		33821900	B1019
Ascantle		33822000	B1018
GC Column		26007900	E3001
A Prepacked Oxygen Pyrolysis Tube			X1020

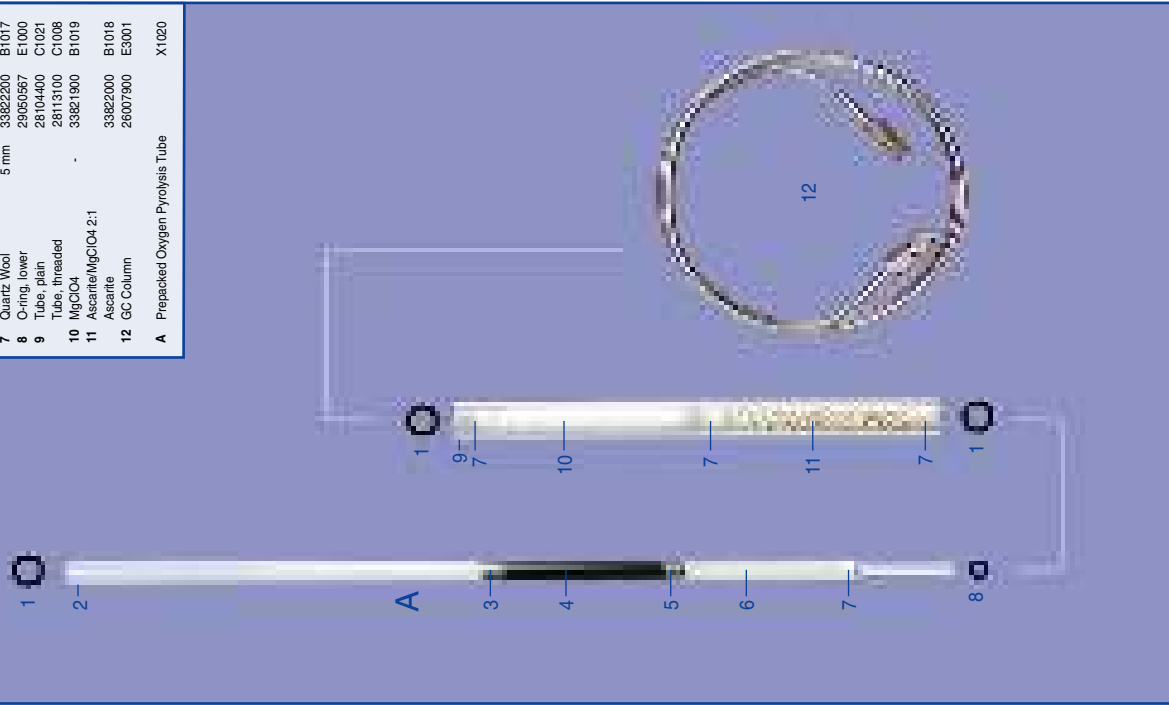

CHN DETERMINATION

		Key	
Product	Qty	CE no	Cat no
1 O-ring, upper		29022910	E1041
2 Combustion Tube, transparent		46820070	C1069
3 Quartz Wool	10mm	33822200	B1017
4 Chromium Oxide	50mm	33822900	B1004
5 Copper Wires, pure	100mm	33835312	B1015
6 Silvered Cobaltous Oxide	50mm	33824500	B1000
7 Quartz Wool	20mm	33822200	B1017
8 O-ring, lower		29022640	E6052
9 GC Column, SS, 2m, 6mm OD		26008200	E3000
A Prepacked Tube			X1151

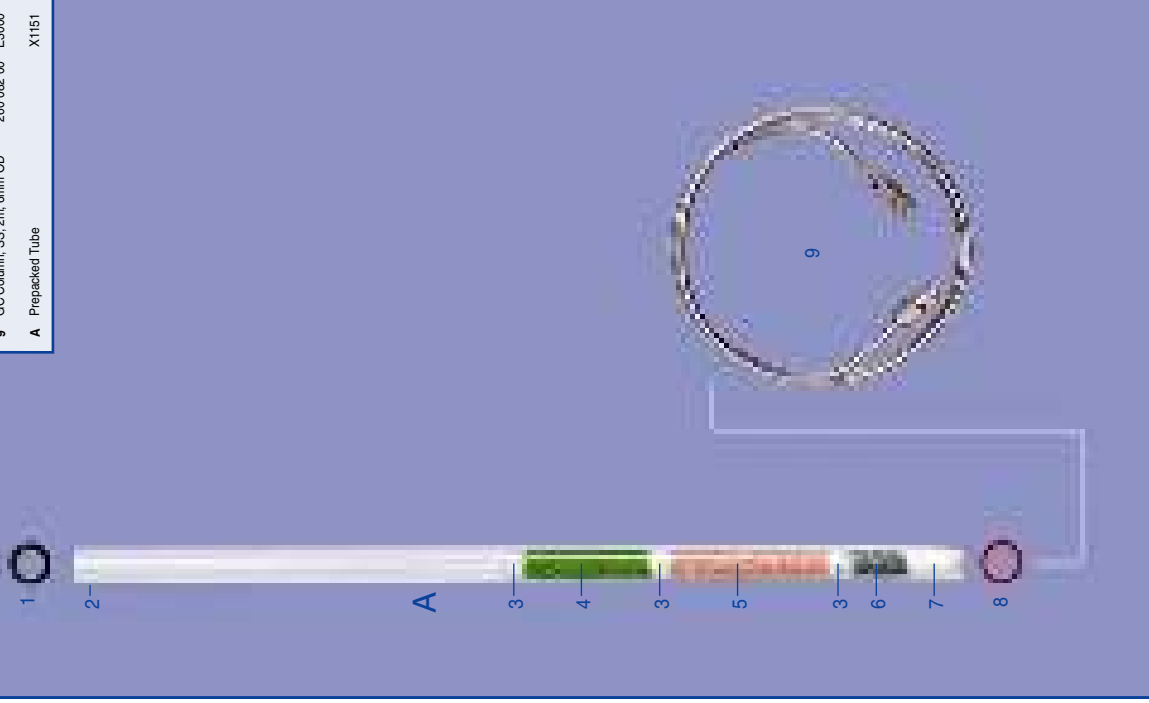

CHNS DETERMINATION

		Key	
Product	Qty	CE no	Cat no
1 O-ring, upper		29022910	E1041
2 Combustion Tube		46820070	C1069
3 Quartz Wool	10mm	33822200	B1017
4 Tungstic Oxide	50mm	33824600	B1025
5 Quartz Wool	20mm	33822200	B1017
6 Copper Wires, high purity	140mm	33822200	B1035
7 O-ring		29020640	E6052
8 Column, SS, 2m, 6mm OD		26007920	E3003
A Prepacked Reaction Tube			X1152

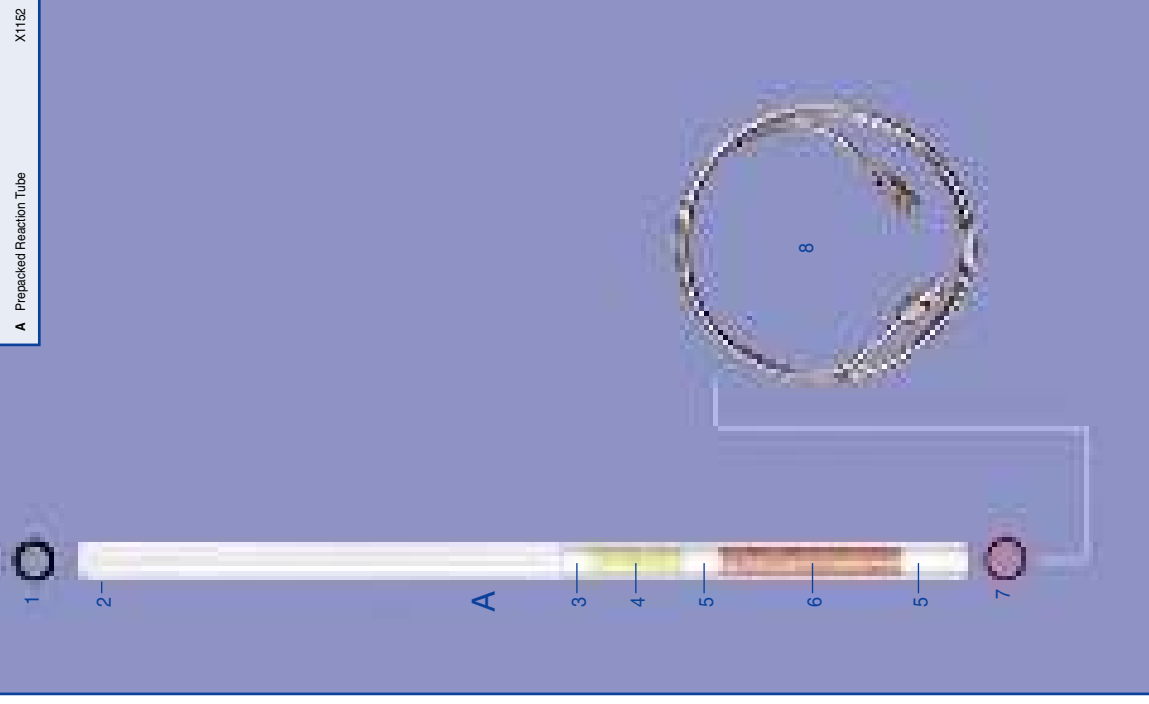

NC DETERMINATION

N DETERMINATION

NCS/S DETERMINATION

Product	Cat no	Qty	CE no	Cat no
A Prepacked Reaction Tube	X1154		290 229 10	E1041
B Prepacked Reduction Tube	X1042		468 200 70	C1069
1 O-ring		10 mm	338 222 00	B1017
2 Combustion Tube, straight		100 mm	338 217 10	B1002
3 Quartz Wool		20 mm	338 229 00	B1004
4 Copper Oxide Wires		50 mm	338 222 00	B1017
5 Quartz Wool		40 mm	338 245 00	B1000
6 Silvered Cobaltous/ic Oxide		50 mm	338 222 00	B1017
7 Quartz Wool		40 mm	338 222 00	B1017
8 O-ring		50 mm	338 222 00	B1017
9 Reduction Tube, straight		350 mm	338 353 12	B1015
10 Quartz Wool		290 136 03	E1021	
11 Copper Wires		281 130 08	C1008	
12 Schott Seal		338 219 00	B1019	
OR Schott Cap Kit		260 079 20	E3000	
13 H ₂ O Scrubber Tube, threaded				
14 Magnesium Perchlorate				
15 GC Column SS, 2 m, 6 mm OD				

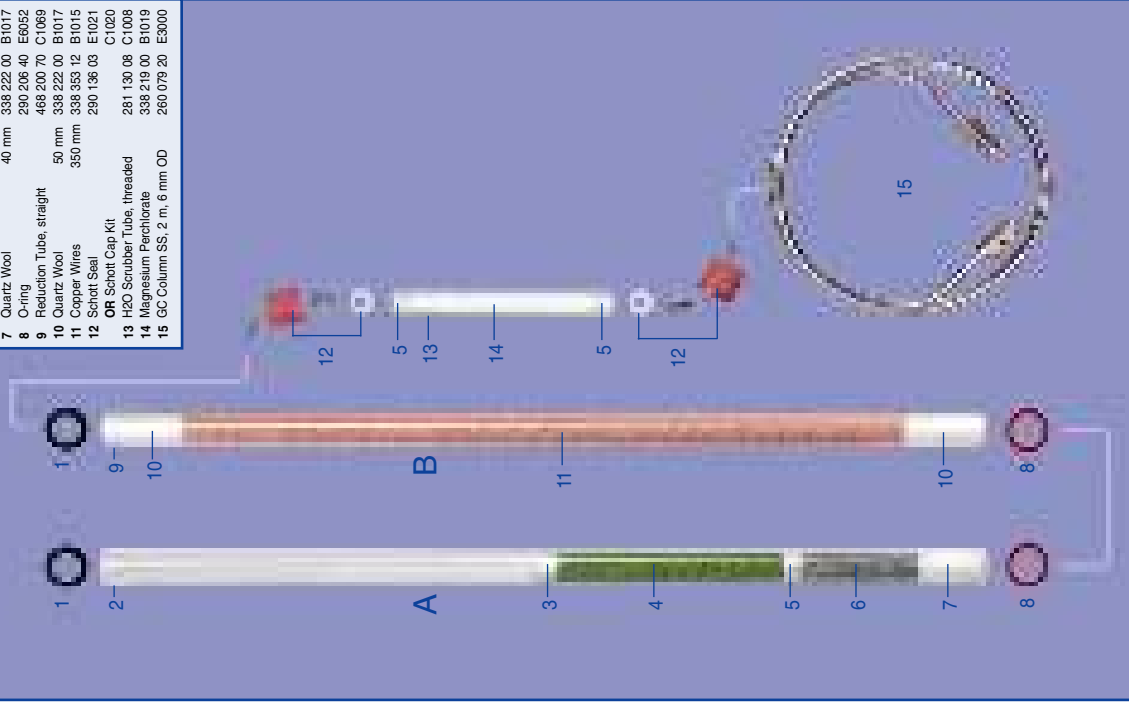

Product	Qty	CE no	Cat no
1 O-ring, upper	10 mm	290 229 10	E1041
2 Combustion Tube	100 mm	468 200 70	C1069
3 Quartz Wool	20 mm	338 222 00	B1017
4 Copper Oxide Wires	50 mm	338 217 10	B1002
5 Quartz Wool	40 mm	338 229 00	B1004
6 Silvered Cobaltous/ic Oxide	50 mm	338 222 00	B1017
7 Quartz Wool	40 mm	338 245 00	B1000
8 O-ring, bottom	50 mm	338 222 00	B1017
9 Quartz Wool	350 mm	338 353 12	B1015
10 Copper Wires	290 100 82	E1059	
11 O-ring for screw cap			
12 Scrubber Tube, large perspex		281 130 60	E2040
13 Soda Lime		338 352 35	B1189
14 Molecular Sieve 3A		338 018 01	B1143
15 Magnesium Perchlorate		338 219 00	B1019
16 GC Column, PTFE, 50 cm, dia 866 mm		260 078 20	E3022
A Prepacked Reaction Tube			X1154
B Prepacked Reduction Tube			X1042



Product	Qty	CE no	Cat no
1 O-ring	10mm	290 229 10	E1041
2 Combustion Tube	50mm	468 200 70	C1069
3 Quartz Wool	20mm	338 222 00	B1017
4 Copper Oxide Wires	140mm	338 217 10	B1002
5 Quartz Wool		338 245 00	B1025
6 Copper Wires, high purity		338 222 00	B1017
7 O-ring		290 206 40	E6952
8 Schott Seal		290 136 03	E1021
OR Schott Cap Kit			
9 H ₂ O Scrubber Tube, threaded		281 130 08	C1008
10 Magnesium Perchlorate		338 219 00	B1019
11 Column, SS, 2m, 6mm OD		260 079 20	E3003
(For S: PTFE White)			
A Prepacked Reaction Tube, using Tungstic Oxide			X1152

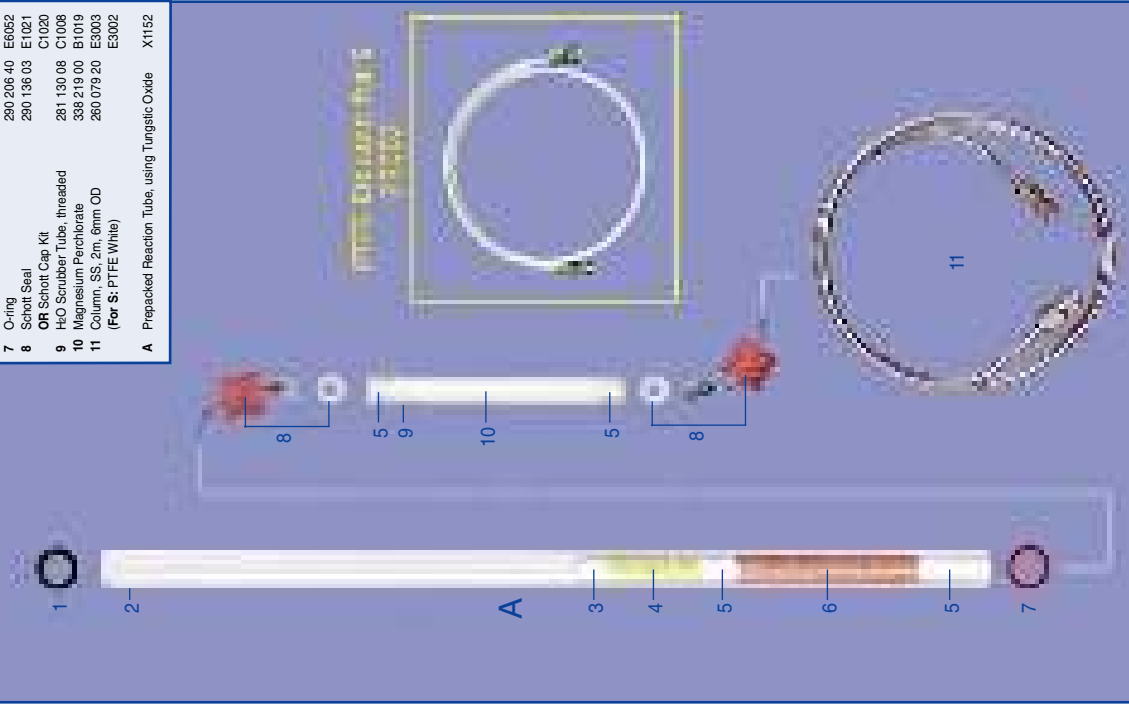

O PYROLYSIS

Product		Qty	CE no	Cat no
1	O-ring, upper	290	229-10	E1041
2	Combustion Tube, opaque	468	200-70	C1069
3	Quartz Wool	338	222-00	B1017
4	Nickelised Carbon, 20%	50mm	338-218-00	B1006
5	Quartz Wool	20mm	338-222-00	B1017
6	Quartz Chips	338	223-00	B1006
7	O-ring, lower	290	206-40	E6052
8	Schott Seal	290	136-03	E1021
9	OR Schott Cap Kit			C1020
10	Soda Line	338	352-35	B1189
11	Magnesium Perchlorate	338	219-00	B1019
	GC Column, SS, 1m, 6mm OD	260	079-00	E3001
A	Prepacked Oxygen Pyrolysis Tube			X1153

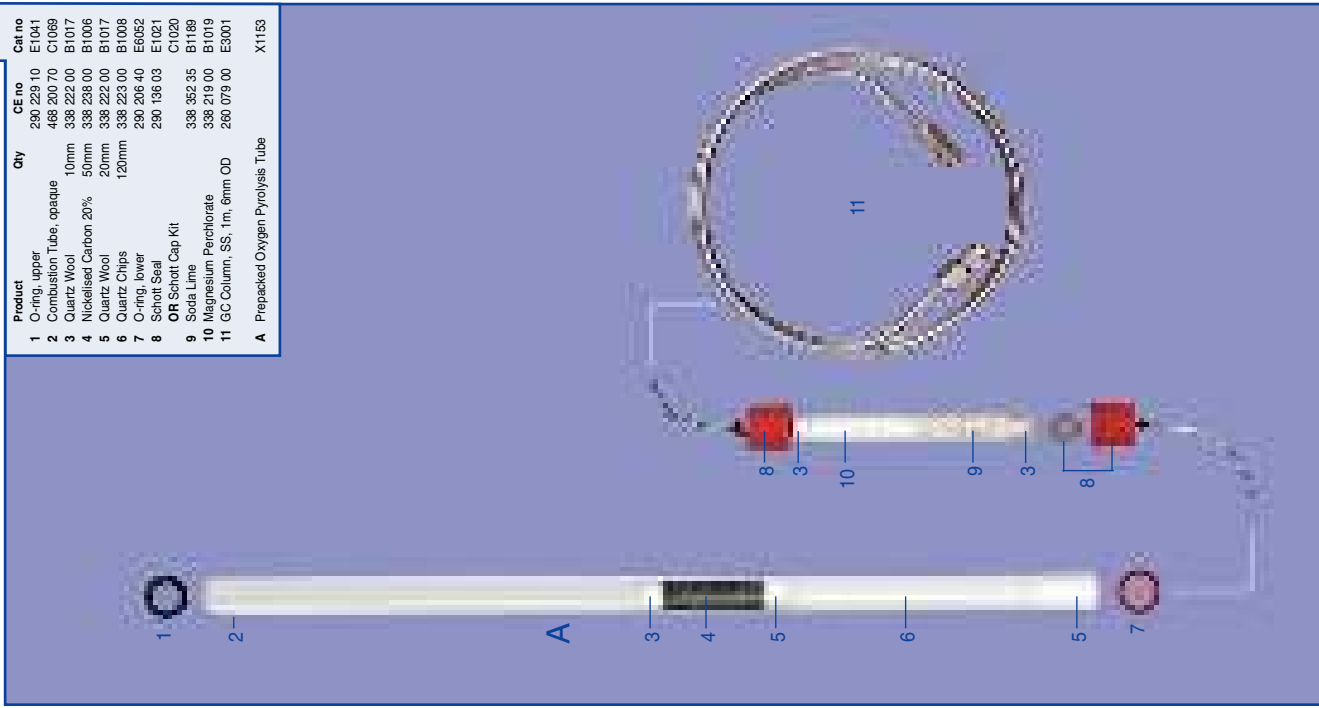

CHN DETERMINATION

Product		Qty	E no	Cat no
1	O-ring, upper	E13536	E1504	
2	Tube	E12509	C1074	
3	Quartz Wool	E10514	B1017	
4	Chromium Oxide, granular	E10101	B1004	
5	Copper Wires	E10120	B1046	
6	Silvered Cobaltous Oxide	E10160	B1000	
7	Quartz Wool	E10514	B1017	
8	O-ring, lower	E13540	E1508	
9	Column, SS	E11505	E3000	
A	Prepacked Tube	E13041	X1250	

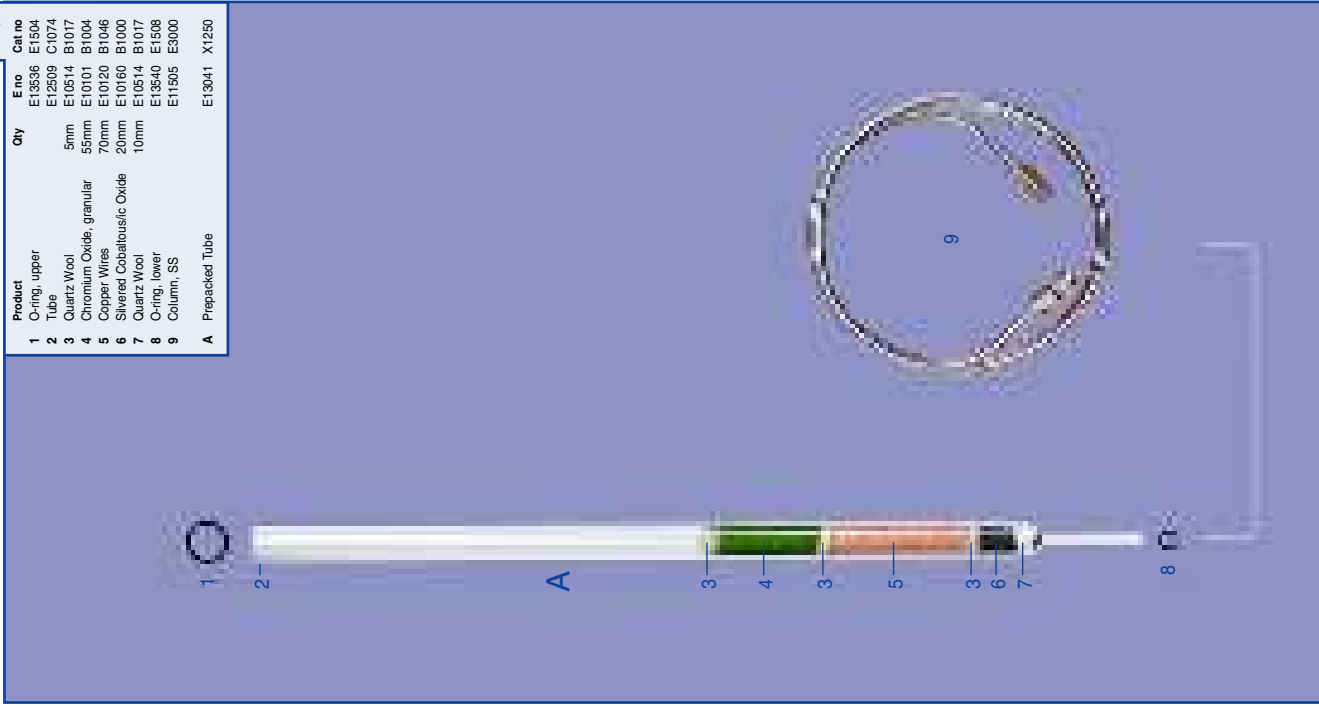

CHN DETERMINATION

Product		Qty	E no	Cat no
1	O-ring, upper	E13536	E1504	
2	Tube	E12509	C1074	
3	Quartz Wool	E10514	B1017	
4	Chromium Oxide, granular	10mm	E10101	B1004
5	Silvered Cobaltous Oxide	40mm	E10160	B1000
6	Quartz Wool	10mm	E10514	B1017
7	O-ring, lower	E13540	E1508	
8	Tube, empty	E12509	C1074	
9	Copper Oxide Wires, coarse	50mm	E10108	B1234
10	Copper Wires, coarse	325mm	E10120	B1046
11	Column, SS	E11505	E3000	
A	Prepacked Reaction Tube	E13036	X1252	
B	Prepacked Reduction Tube	E13037	X1254	

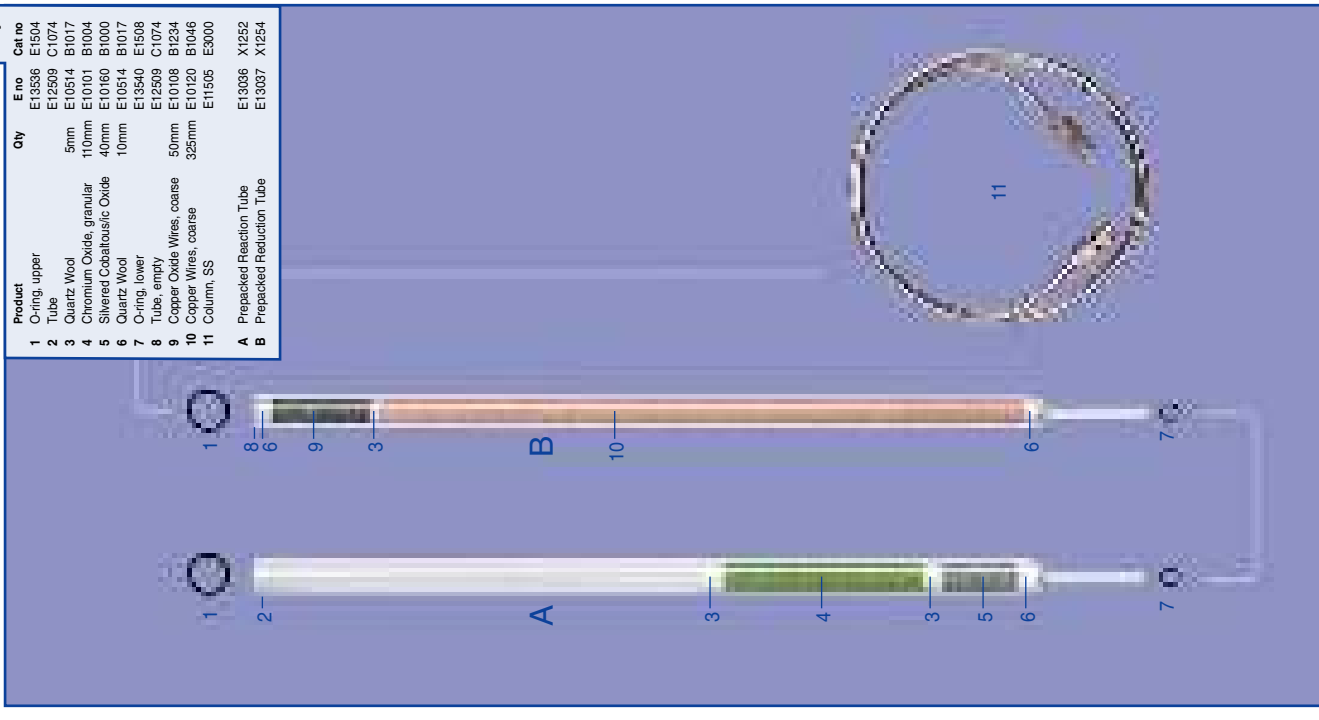

CN/N DETERMINATION

Product	Qty	E.no	Cat.no
a Quartz Wool	10mm	E13536	E1504
b Tube	155mm	E13505	C1074
c Carbosorb 0.7-1.2mm	5mm	E10514	B1017
d Quartz Wool	70mm	E10503	B1236
e Magnesium Perchlorate, granular		E10514	B1017
		E10507	B1019
1 O-ring, upper		E13536	E1504
2 Tube		E12509	C1074
3 Quartz Wool		E10514	B1017
4 Chromium Oxide, granular		E10101	B1004
5 Silvered Cobaltous/sic Oxide		E10160	B1000
6 Quartz Wool		E10514	B1017
7 O-ring, lower		E13540	E1508
8 Tube, empty		E12509	C1074
9 Copper Oxide Wires, coarse		E10108	B1234
10 Copper Wires, coarse		E10120	B1046
11 Schott Cap Kit		EA213542	E1021
OR Schott Seal		E13501	C1008
12 Tube		E10507	B1019
13 Magnesium Perchlorate, granular		E11510	E3004
14 Column, SS		E13036	X1252
F Prepacked Reaction Tube		E13037	X1254

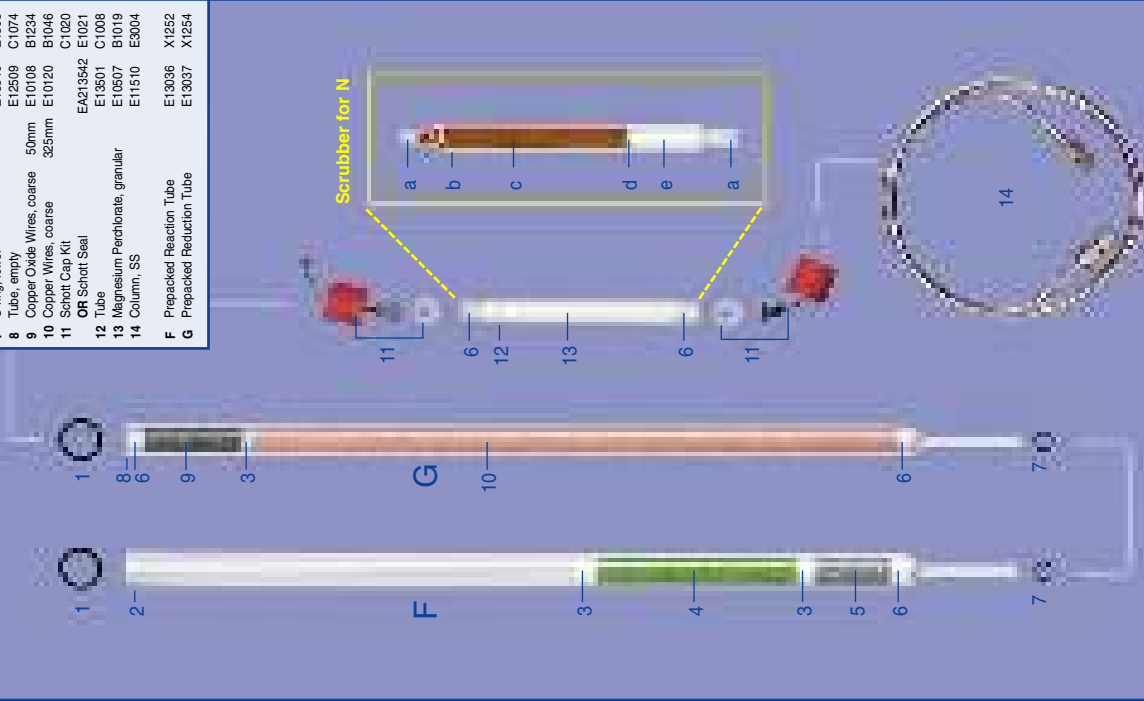

CHNS DETERMINATION

Product	Qty	E.no	Cat.no
1 O-ring, upper		E13536	E1504
2 Tube		E12509	C1074
3 Quartz Wool		E10514	B1017
4 Tungstic Oxide, granular		E10152	B1025
5 Copper Wires		E10130	B1035
6 O-ring, lower		E13540	E1508
7 Column, SS		E11501	E3003
A Prepacked Tube		E13040	X1074

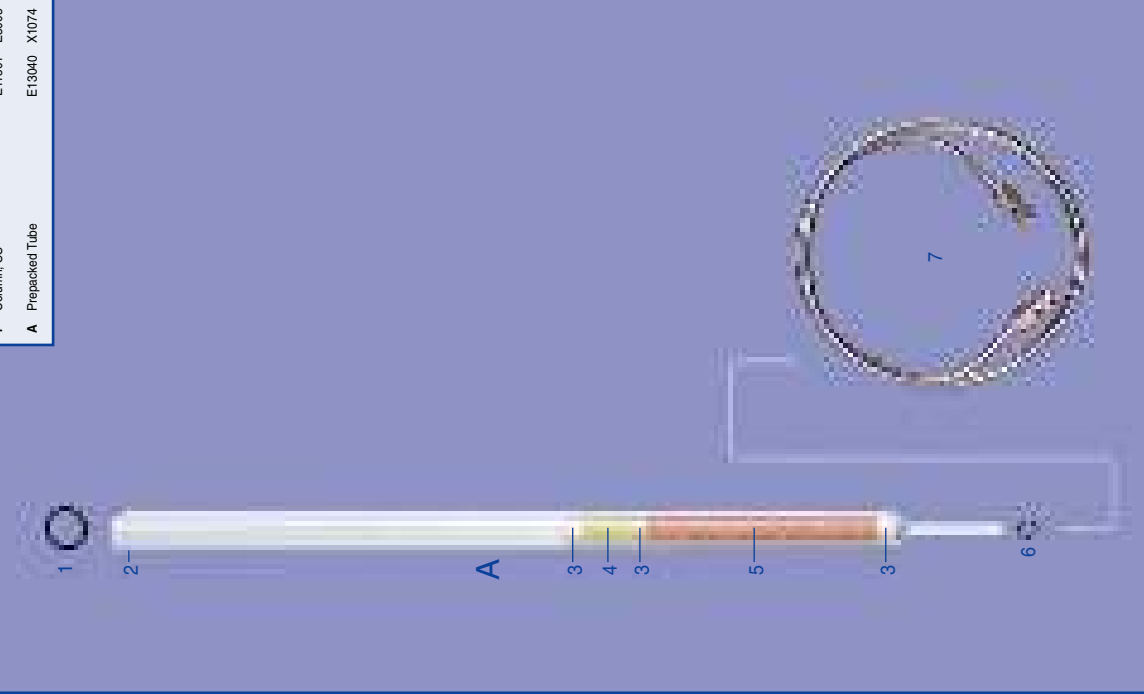

S DETERMINATION

Product	Qty	E.no	Cat.no
1 O-ring, upper		E13536	E1504
2 Tube		E12509	C1074
3 Quartz Wool		E10514	B1017
4 Tungstic Oxide, granular		E10152	B1025
5 Copper Wires		E10130	B1035
6 O-ring, lower		E13540	E1508
7 Schott Cap Kit		EA213542	E1021
OR Schott Seal		E13501	C1008
8 Tube		E10507	B1019
9 Magnesium Perchlorate, granular		E11515	E3002
10 GC Column, PTFE		E13040	X1074
A Prepacked Tube			

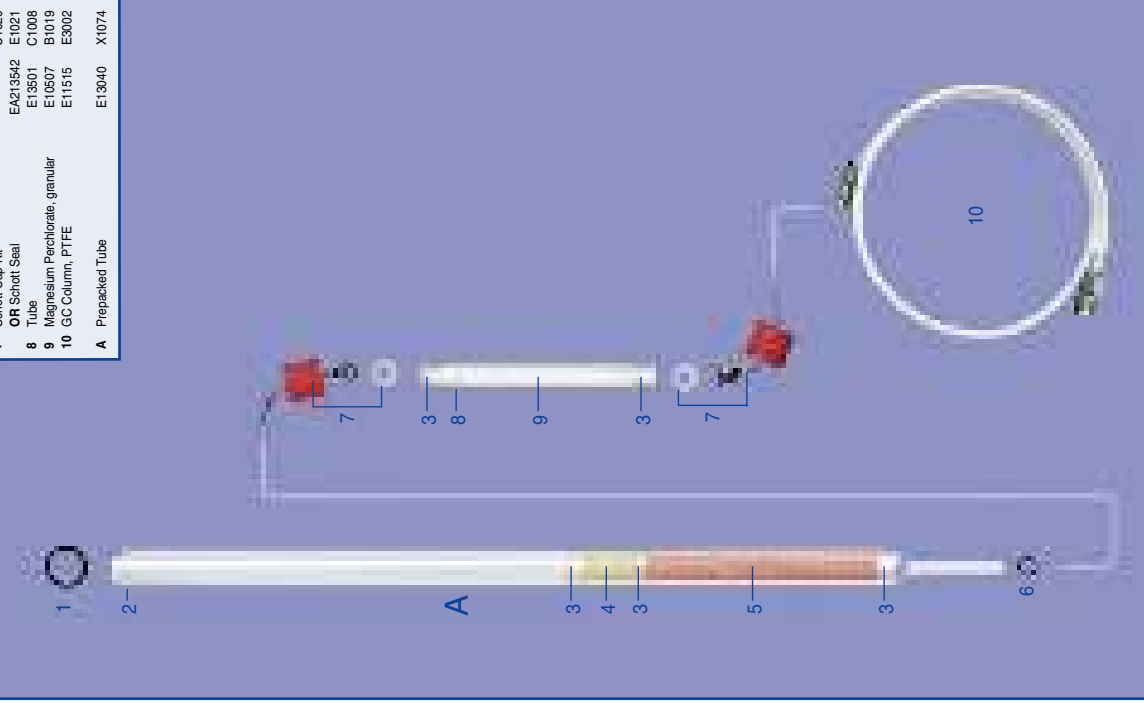

O PYROLYSIS

Product	Qty	E no	Cat no	Key
1 O-ring, upper		E13536	E1504	
2 Tube		E12509	C1074	
3 Nickelised Carbon, granular	5mm	E10510	B1007	
4 Nickelised Carbon, granular	40mm	E10145	B1182	
5 Quartz Chips	110mm	E10513	B1008	
6 Quartz Wool	10mm	E10514	B1017	
7 O-ring, lower		E13540	E1508	
8 Schott Cap Kit		E13515	C1020	
OR Schott Seal		EA213542	E1021	
9 Tube		E13501	C1008	
10 Carbosorb 0,6-1,4mm		E10505	B1042	
11 Magnesium Perchlorate, granular		E10507	B1019	
12 GC Column		E11520	E3001	
A Prepacked Oxygen Pyrolysis Tube		E13043	X1256	

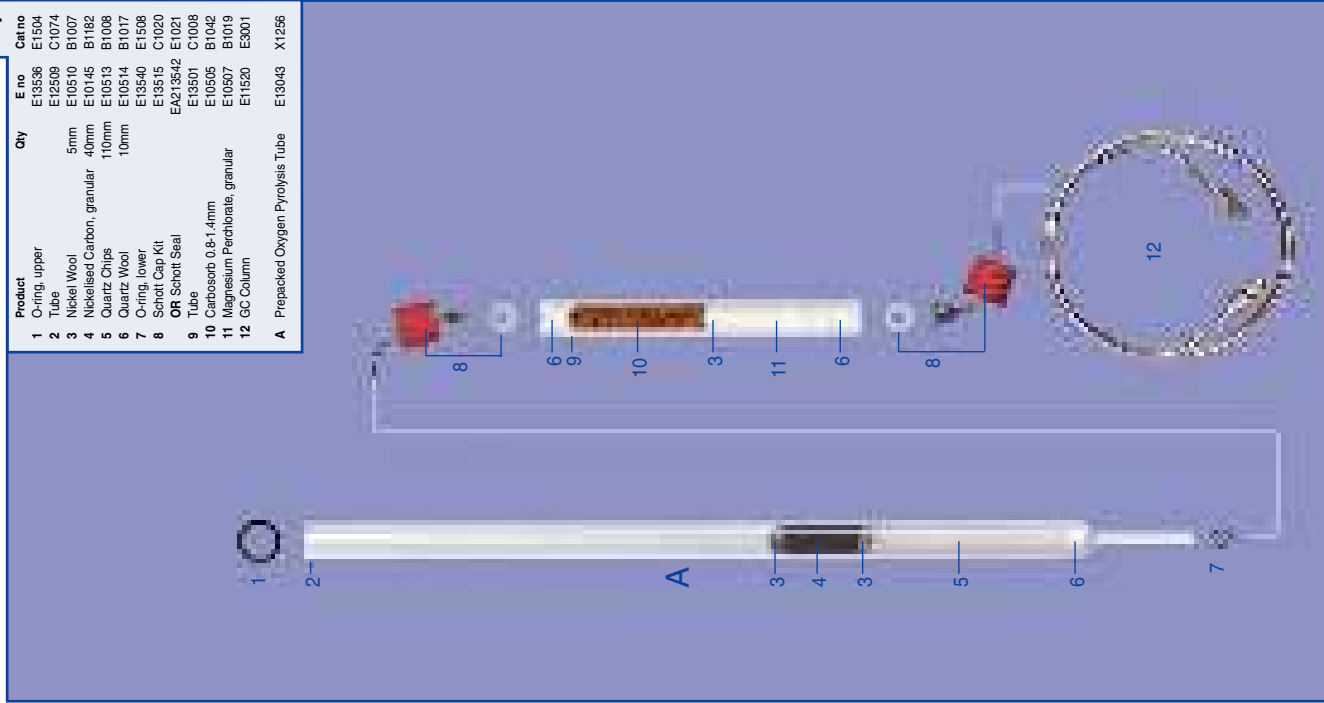

NCS DETERMINATION

Product	Qty	E no	Cat no	Key
1 O-ring, upper		E13536	E1504	
2 Tube		E12509	C1074	
3 Quartz Wool	10mm	E10514	B1017	
4 Tungstic Oxide, granular	25mm	E10162	B1025	
5 Copper Wires	120mm	E10130	B1035	
6 O-ring, lower		E13540	E1508	
7 Schott Cap Kit		EA213542	C1020	
OR Schott Seal		E13501	C1008	
8 Tube		E10507	B1019	
9 Magnesium Perchlorate, granular		E11501	E3003	
10 GC Column, SS		E13040	X1074	
A Prepacked Tube				

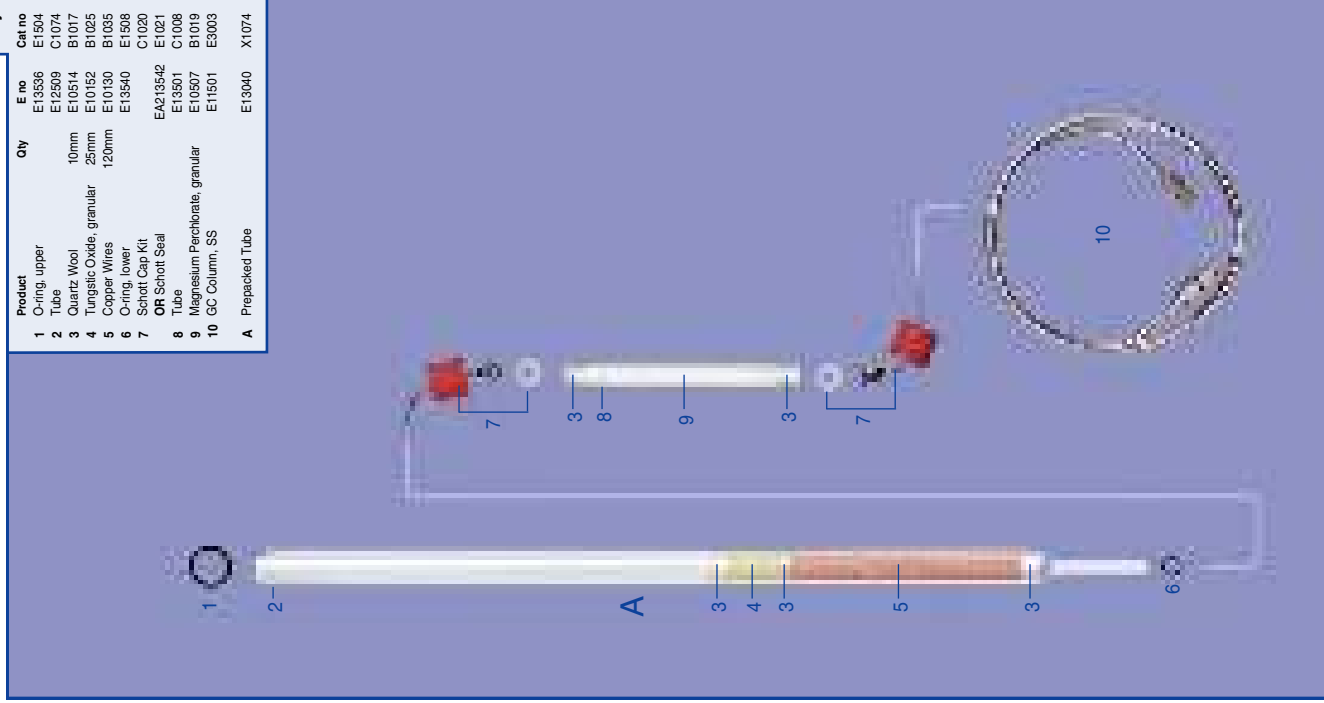

CN/N DETERMINATION

Product	Qty	E no	Cat no	Key
a Quartz Wool	10mm	E10514	B1017	
b Tube		E13505	C1014	
c Carbosorb 0,7-1,2mm	155mm	E10503	B1236	
d Quartz Wool	5mm	E10514	B1017	
e Magnesium Perchlorate, granular	70mm	E10507	B1019	
1 O-ring, upper		E13536	E1504	
2 Tube, 18mm, clear		E12510	C1089	
3 Quartz Wool	5mm	E12515	C1023	
4 Cr ₂ O ₃	100mm	E10101	B1004	
5 Silvered Cobaltous Oxide	50mm	E10160	B1000	
6 Quartz Chips	50mm	E10512	B1008	
7 Quartz Wool	10mm	E10514	B1017	
8 O-ring, lower		E13537	E1505	
9 Quartz Wool	20mm	E10514	B1017	
10 Quartz Chips	50mm	E10512	B1008	
11 Copper Wires	310mm	E10120	B1046	
12 Schott Cap Kit		EA213542	C1020	
OR Schott Seal		E13501	C1008	
13 Tube		E10507	B1019	
14 Magnesium Perchlorate, granular		E11505	E3000	
15 Column, SS		E13005	X1256	
F Prepacked Combustion Tube		E13010	X1260	
G Prepacked Reduction Tube				

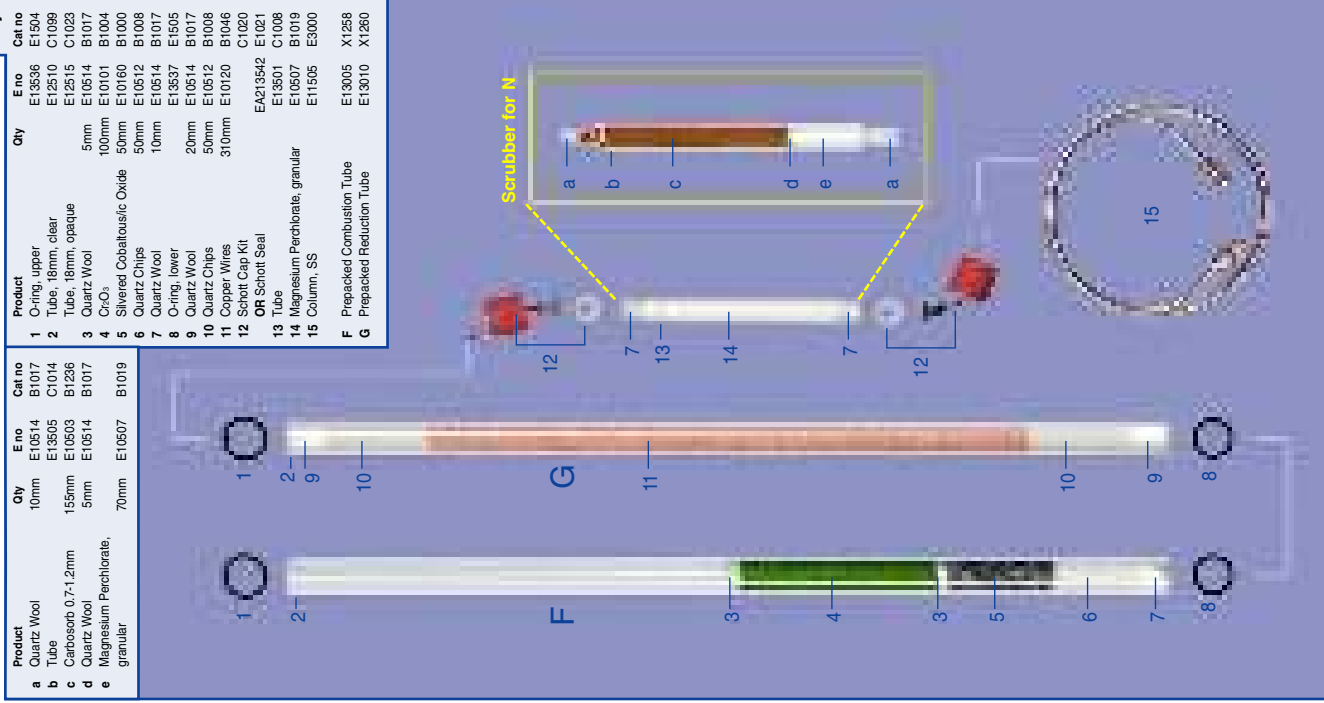

CHN DETERMINATION

Product	Qty	Ero	Cat no
1 O-ring, upper		E13536	E1504
2 Tube		E12510	C1099
3 Quartz Wool	5mm	E10514	B1017
4 Cr2O3	45mm	E10101	B1004
5 Copper Wires	65mm	E10120	B1046
6 Silvered Cobaltous/Co Oxide	30mm	E10160	B1000
7 Quartz Chips	50mm	E10512	B1008
8 Quartz Wool	10mm	E10514	B1017
9 O-ring, lower		E13537	E1505
10 Column, SS		E11505	E3000
A Prepacked Tube		E13000	X1282



CHN DETERMINATION

Product	Qty	Ero	Cat no
1 O-ring, upper		E13536	E1504
2 Tube, clear		E12510	C1099
3 Quartz Wool	5mm	E10514	B1017
4 Cr2O3	100mm	E10101	B1004
5 Silvered Cobaltous/Co Oxide	50mm	E10160	B1000
6 Quartz Chips	50mm	E10512	B1008
7 Quartz Wool	10mm	E10514	B1017
8 O-ring, lower		E13540	E1508
9 Quartz Wool	20mm	E10514	B1017
10 Copper Wires	310mm	E10120	B1046
11 Column, SS		E11505	E3000
A Prepacked Combustion Tube		E13005	X1298
B Prepacked Reduction Tube		E13010	X1260

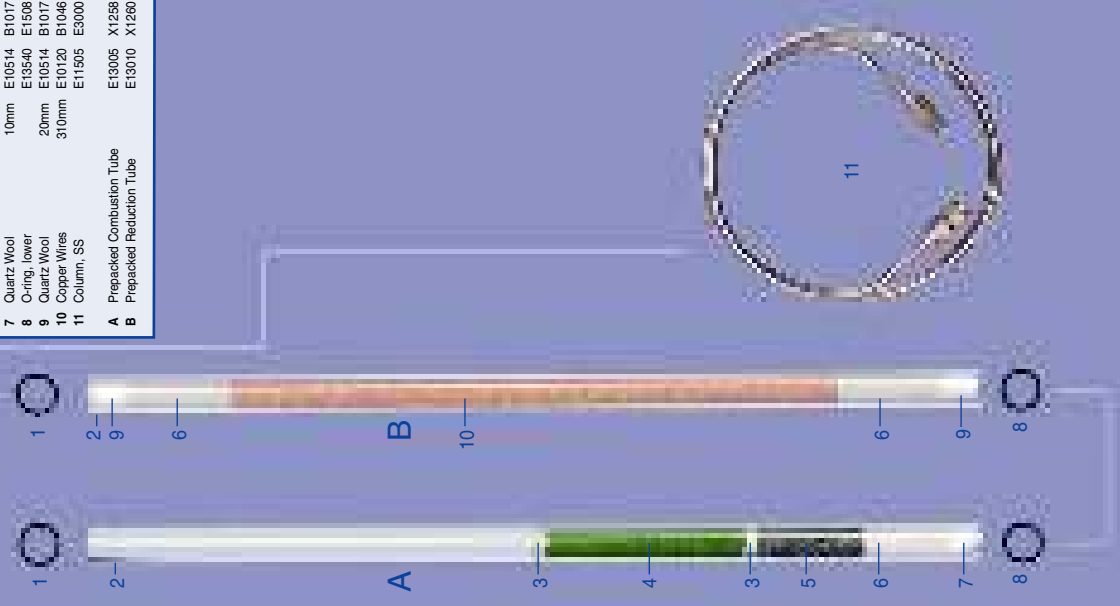

CHNS DETERMINATION

Product	Qty	Ero	Cat no
1 O-ring, upper		E13536	E1504
2 Tube, clear		E12510	C1099
3 Quartz Wool	10mm	E10514	B1017
4 Tungstic Oxide on Alumina (or pure granular)	60mm	E10156	B1031
5 Copper Wires	90mm	E10152	B1025
6 Quartz Chips	50mm	E10130	B1040
7 O-ring, lower		E10512	B1008
8 GC Column, SS		E13537	E1505
A Prepacked Tube		E11501	E3003
		E13001	X1264

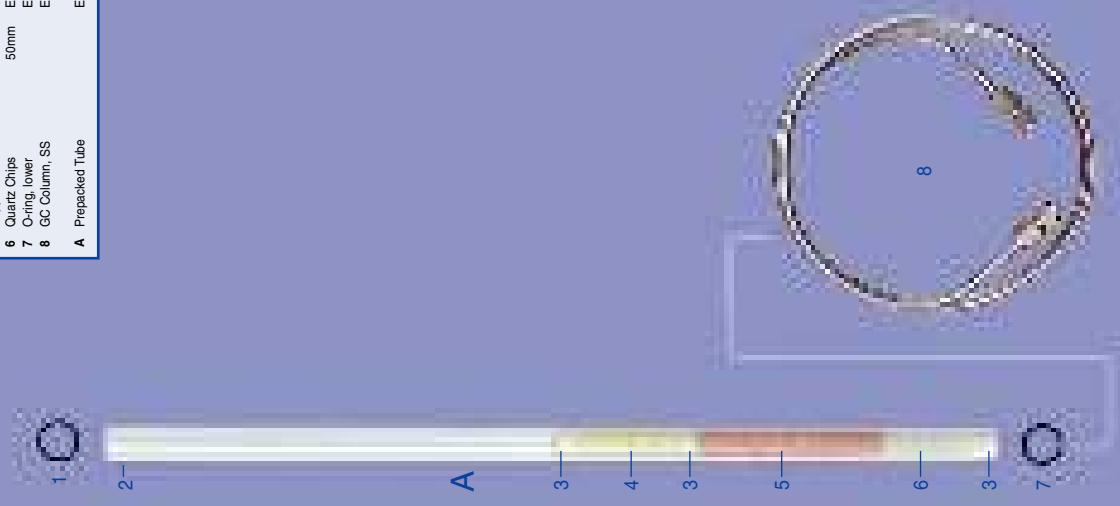

O PYROLYSIS

Key	
Product	E no
1 O-ring, upper	E13536
2 Tube, clear	E1504
3 Nickel Wool	E12510
4 Nickelised Carbon Chips	C1099
5 Quartz Chips	E10145
6 Quartz Wool	B1182
7 O-ring, lower	E10513
8 Schott Cap Kit	E10514
9 Quartz Wool	E13537
10 Tube	E13515
11 Carbosorb 0.8-1.4mm	EA213542
12 Quartz Wool	E10514
13 Magnesium Perchlorate, granular	E10505
14 GC Column	E10514
A Prepacked Oxygen Pyrolysis Tube	E11520
	E3001
	X1266

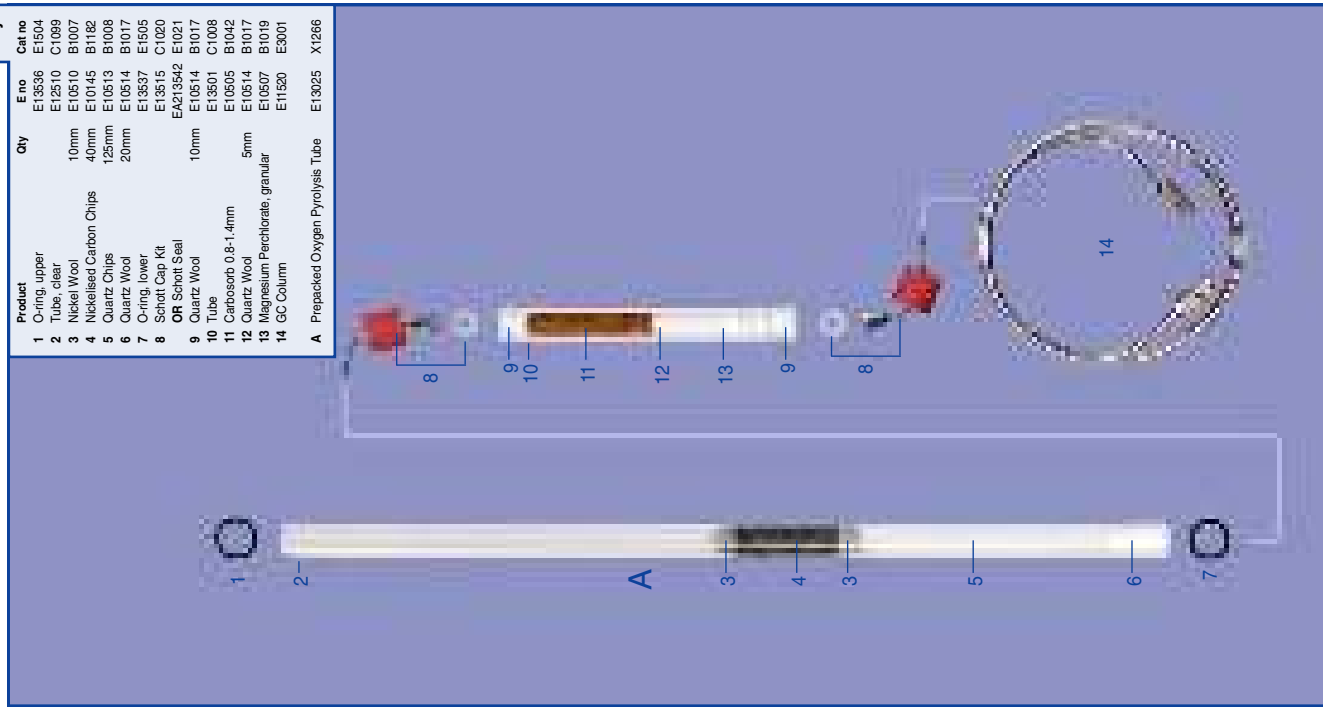

S DETERMINATION

Key	
Product	E no
1 O-ring, upper	E13536
2 Tube, clear	E1504
3 Quartz Wool	E12510
4 Tungstic Oxide on Alumina (or Tungstic Oxide)	C1023
5 Copper Wires	E10514
6 Quartz Chips	E10156
7 O-ring, lower	E10152
8 Schott Cap Kit	E13537
9 Tube	EA213542
10 Magnesium Perchlorate, granular	E13501
11 GC Column, PTFE	E10507
A Prepacked Tube	E11515
	E3002
	X1264

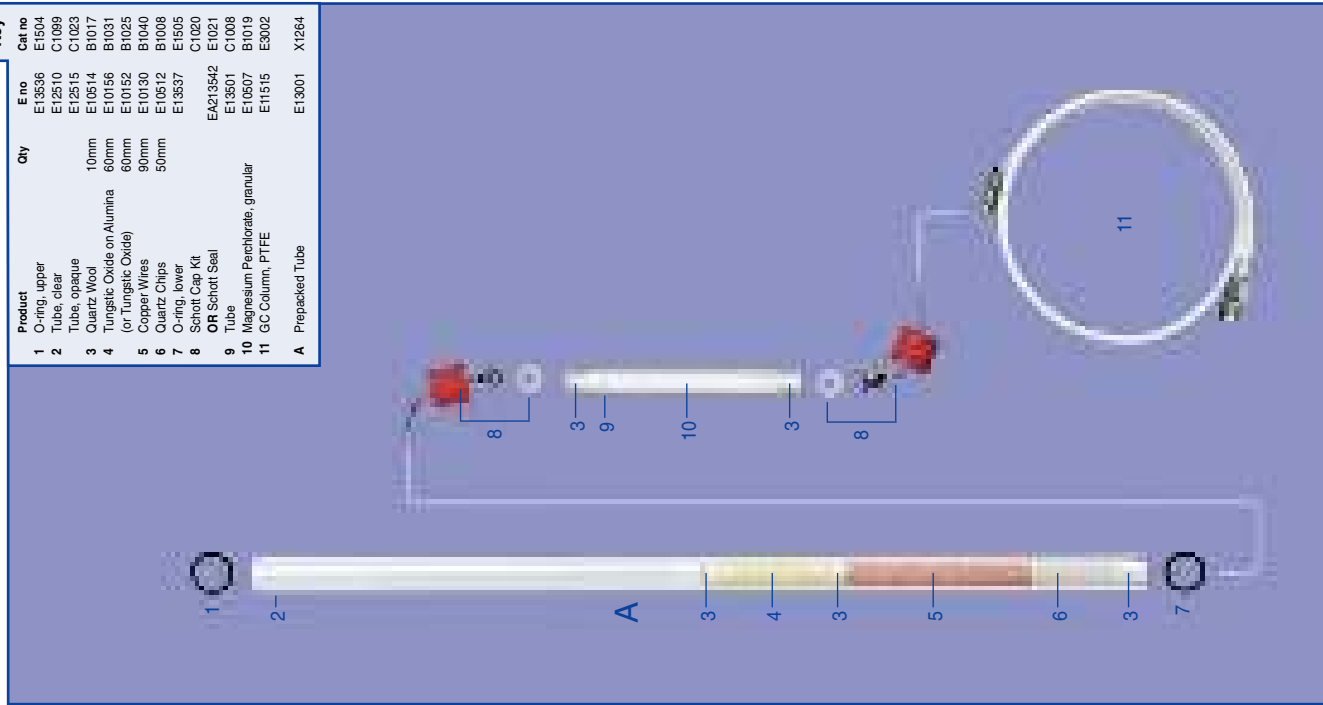

NCS DETERMINATION

Key	
Product	E no
1 O-ring, upper	E13536
2 Tube, clear, empty	E1504
3 Quartz Wool	E12510
4 Tungstic Oxide on Alumina (or pure granular)	C1023
5 Copper Wires	E10514
6 Quartz Chips	E10156
7 O-ring, lower	E10152
8 Schott Cap Kit	E13537
9 Tube	EA213542
10 Magnesium Perchlorate, granular	E13501
11 GC Column, SS	E10507
A Prepacked Tube	E11501
	E3003
	X1264

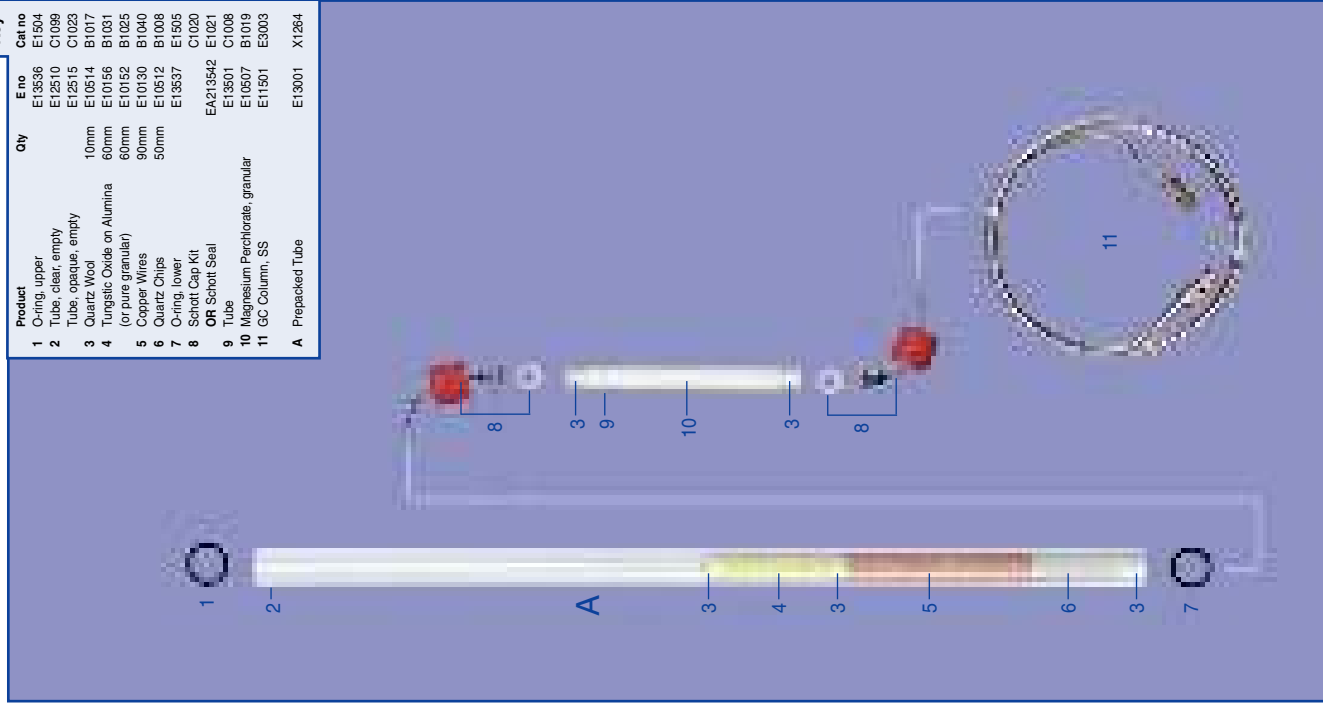

CHN DETERMINATION

Product	Cat no	Qty	Elementar no	Cat no	Key
A Prepacked Reduction Tube Vario EL3 using C3009 (11.00-1150/4) tube	X2500				
1 Combustion Tube	11.00-1150/4	3 mm	C3009	C3009	
2 Corundum Balls	50 008 467	90 mm	B1090	B1090	
3 Copper Oxide Wires	03 679 905	5 mm	B1122	B1122	
4 Quartz Wool	03 679 908	20 mm	B1208	B1208	
5 Cerium Dioxide, granular	03 679 915	20 mm	B1028	B1028	
6 Lead Chromate, granular	03 679 914	20 mm	B1207	B1207	
7 Connecting Tube	11.00-1331		C3022	C3022	
8 Reaction Tube	11.00-1308/4		C3010	C3010	
Note: EL3 uses					
9 Silver Wool	22 131 365	20 mm	B1231	B1231	
10 Copper Wires	03 679 925		B1015	B1015	

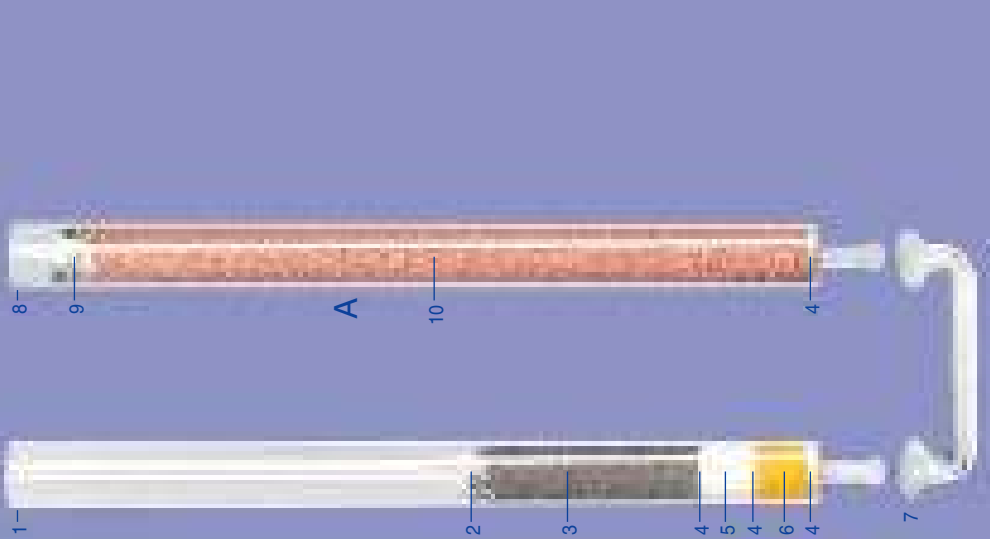

CHNS DETERMINATION

Product	Cat no	Qty	Elementar no	Cat no	Key
a Combustion Tube, early version	11.00-1150/4	10 mm	C3009	C3009	
b Alumina Wool	05 000 086	133 mm	B1089	B1089	
c Support Tube	11.00-1171/4	15 mm	C3016	C3016	
d Quartz Wool	03 679 908	15 mm	B1017	B1017	
E Prepacked Reaction Tube using C3009 tube	X2502				
F Prepacked Reduction Tube	X2501				
1 Combustion Tube	11.00-1150/4	3 mm	C3009	C3009	
2 Corundum Balls	50 008 467	55 mm	B1217	B1217	
3 Tungsten (VI) Oxide, granular	11.02-0008	10 mm	B1208	B1208	
4 Quartz Wool	03 679 908	65 mm	C3017	C3017	
5 Support Tube	11.00-1172/4	5 mm	B1208	B1208	
6 Quartz Wool	03 679 908		C3022	C3022	
7 Connecting Tube	11.00-1308/4		C3010	C3010	
8 Reaction Tube	11.00-1308/4		C3009	C3009	
Note: EL3 uses					
9 Silver Wool	22 131 365	25 mm	B1231	B1231	
10 Corundum Balls	50 008 467	46 mm	B1090	B1090	
11 Copper Wires	03 679 924	170 mm	B1015	B1015	

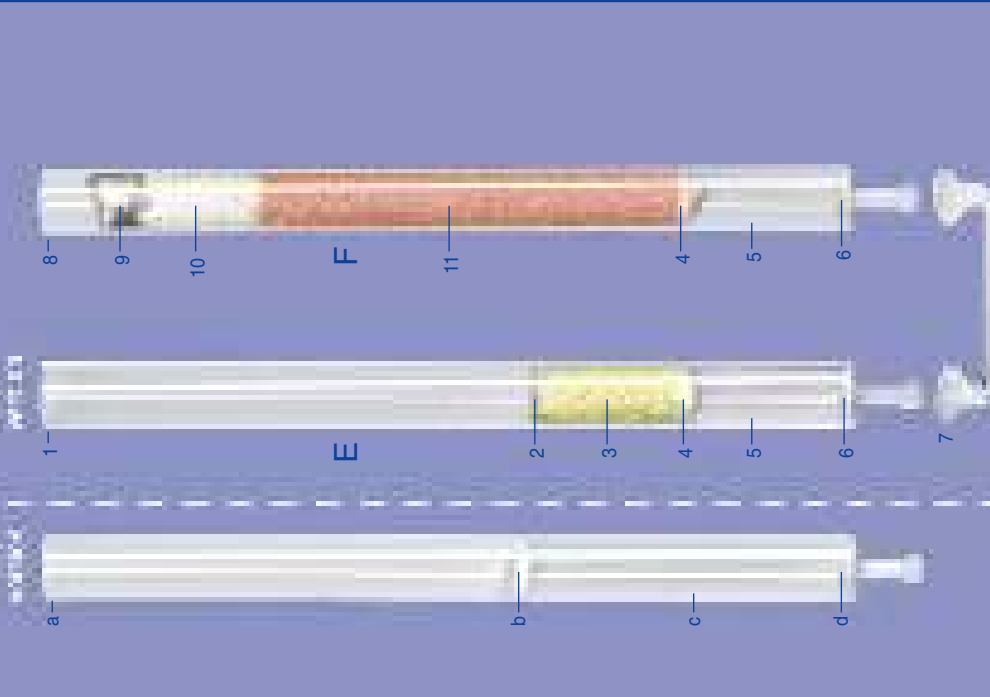

CNS DETERMINATION

Product	Cat no	Qty	Elementar no	Cat no	Key
a Combustion Tube, early version	11.00-1150/4	10 mm	C3009	C3009	
b Alumina Wool	05 000 086	133 mm	B1089	B1089	
c Support Tube	11.00-1171/4	15 mm	C3016	C3016	
d Quartz Wool	03 679 908	15 mm	B1017	B1017	
E Prepacked Reaction Tube using C3009 tube	X2502				
F Prepacked Reduction Tube	X2501				
1 Combustion Tube	11.00-1150/4	3 mm	C3009	C3009	
2 Corundum Balls	50 008 467	55 mm	B1217	B1217	
3 Tungsten (VI) Oxide, granular	11.02-0008	10 mm	B1208	B1208	
4 Quartz Wool	03 679 908	65 mm	C3017	C3017	
5 Support Tube	11.00-1172/4	5 mm	B1208	B1208	
6 Quartz Wool	03 679 908		C3022	C3022	
7 Connecting Tube	11.00-1308/4		C3010	C3010	
8 Reaction Tube	11.00-1308/4		C3009	C3009	
Note: EL3 uses					
9 Silver Wool	22 131 365	25 mm	B1231	B1231	
10 Corundum Balls	50 008 467	45 mm	B1090	B1090	
11 Copper Wires	03 679 924	170 mm	B1015	B1015	
12 Tube	22 160 301/4	20 mm	C3015	C3015	
13 Quartz Wool	03 679 908		B1017	B1017	
14 Siccant	03 960 352		B1197	B1197	

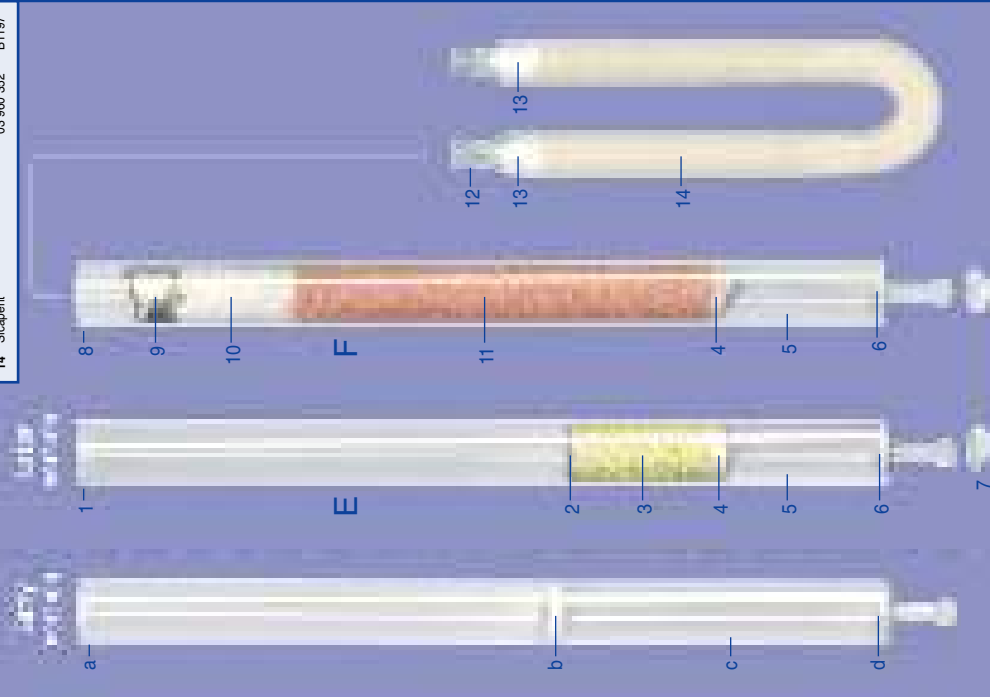

N DETERMINATION

Product	Cat no	Elementar no	Qty	Key
A Prepacked Reduction Tube				
Vario EL3 - using C3009 (11.00-1150/4) tube	X2500	11.00-1150/4		C3009
Combustion Tube		11.00-1150/4	3 mm	B1090
Conundum Balls		50.008.467	90 mm	B1122
Copper Oxide Wires		03.679.905	5 mm	B1206
Quartz Wool		03.679.908	20 mm	B1207
Cerium Dioxide, granular		03.679.915	20 mm	B1208
Lead Chromate, granular		11.00-1331	20 mm	C3022
Connecting Tube		11.00-1308/4		C3010
Reaction Tube		11.00-1150/4		C3009
Note: EL3 uses				
Silver Wool		22.127.245	20 mm	B1015
Copper Wires		03.679.925	20 mm	B1231
Tube		22.160.301/4	20 mm	C3015
Quartz Wool		03.679.908	20 mm	B1208
Sicapent		03.960.352		B1197
Soda Lime/Quartz Chips 1:1		03.679.900		B1169
Quartz Chips		03.679.907		B1214

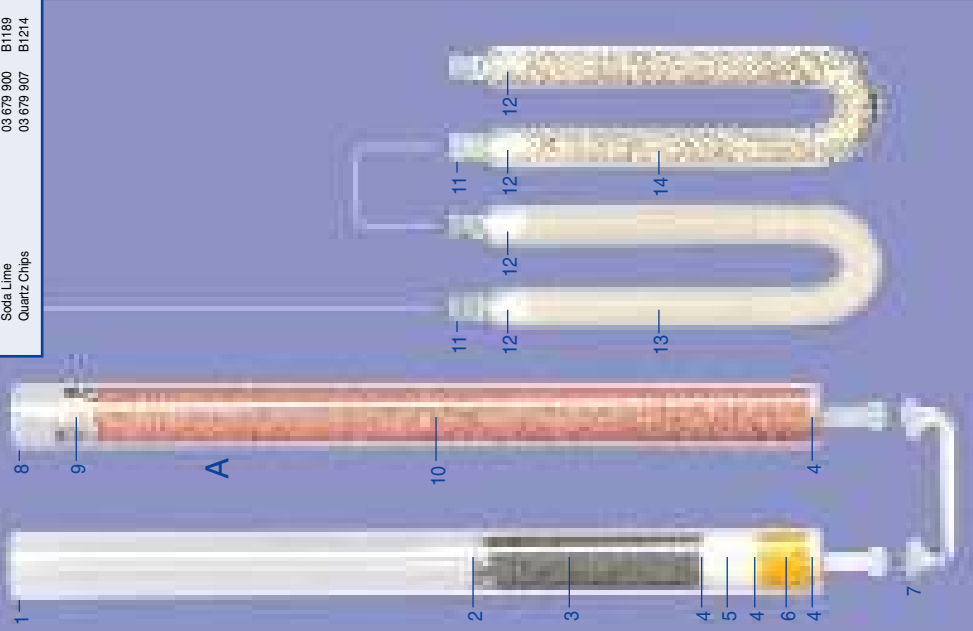

CN DETERMINATION

Product	Cat no	Elementar no	Qty	Key
A Prepacked Reduction Tube				
Vario EL3 - using C3009 (11.00-1150/4) tube	X2500	11.00-1150/4		C3009
Combustion Tube		11.00-1150/4	3 mm	B1090
Conundum Balls		50.008.467	90 mm	B1122
Copper Oxide Wires		03.679.905	5 mm	B1206
Quartz Wool		03.679.908	20 mm	B1207
Cerium Dioxide, granular		03.679.915	20 mm	B1208
Lead Chromate, granular		11.00-1331	20 mm	C3022
Connecting Tube		11.00-1308/4		C3010
Reaction Tube		11.00-1150/4		C3009
Note: EL3 uses				
Silver Wool		22.127.245	20 mm	B1015
Copper Wires		03.679.925	20 mm	B1231
Tube		22.160.301/4	20 mm	C3015
Quartz Wool		03.679.908	20 mm	B1208
Sicapent		03.960.352		B1197

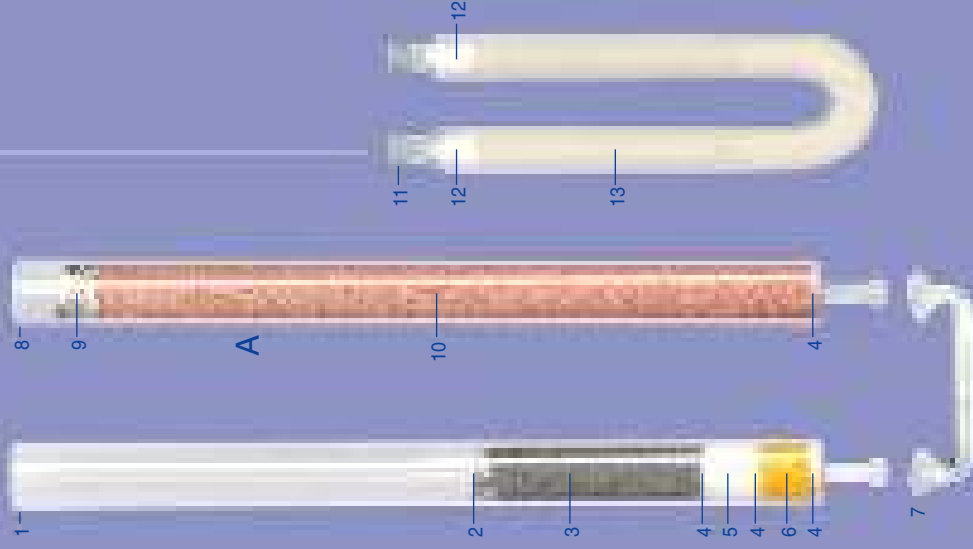

CHN DETERMINATION

Product	Qty	Elementar no	Cat no	Key
1 O-ring, upper		03.654.814	E1055	
2 Combustion Tube		22.133.210/3	C3019	
3 Copper Oxide Wires		03.679.905	B1218	
4 Inner tube containing: Nickel Gauze Peliclapade		22.127.313	D6001	
5 Combustion Tube insert, silica		-	-	
6 Quartz Wool (inner tube)	10 mm	03.679.908	B1208	
7 Cerium Oxide (inner tube)	30 mm	03.679.915	B1028	
8 O-ring	2.5 g	22.131.365	B1231	
9 Lead Chromate	6 g	03.654.603	E1016	
10 Quartz Wool	5 mm	03.679.914	B1207	
11 Reduction Tube		03.679.908	B1208	
12 Copper Wires		22.127.245	C3005	
		03.679.924	B1015	

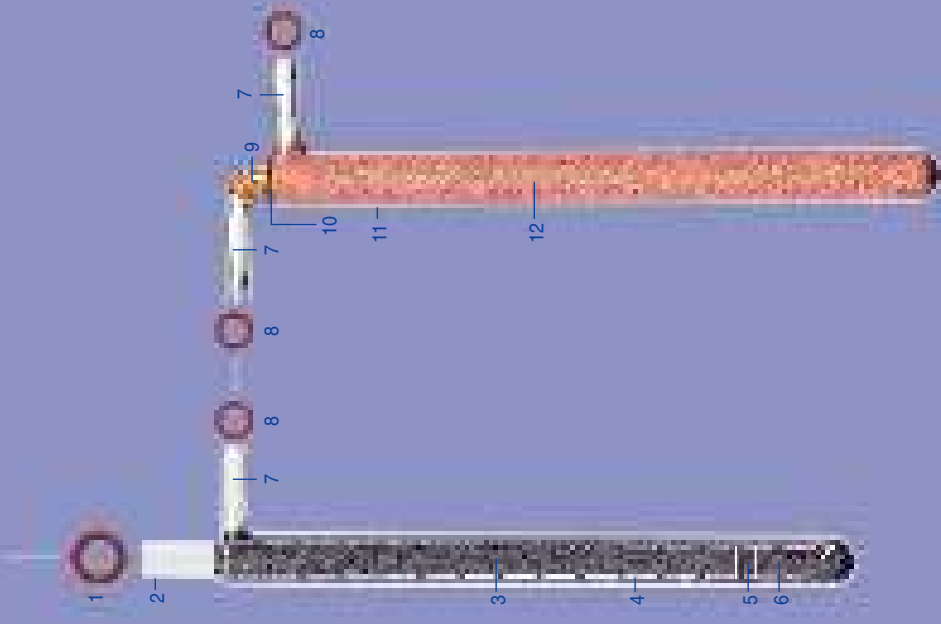

CN DETERMINATION

Product	Qty	Elementar no	Cat no
1 O-ring, upper	03 854 814	E1055	C3019
2 Combustion Tube	22 133 210/3	C3019	B1214
3 Copper Oxide Wires	03 679 905	B1218	B1043
4 Inner tube containing: Nickel Gauze Receptacle	22 127 313	D6001	C3020
5 Quartz Wool (inner tube)	10 mm	03 679 908	B1208
6 Cerium Oxide (inner tube)	30 mm	03 679 915	B1028
7 Silver Wool	2,5 g	22 131 365	B1231
8 O-ring	03 854 603	E1016	
9 Lead Chromate	6 g	03 679 914	B1207
10 Quartz Wool	5 mm	03 679 908	B1208
11 Reduction Tube	22 127 245	C3005	
12 Copper Wires	03 679 924	B1015	
13 Tube	22 160 294	C3007	
14 Quartz Wool	10 mm	03 679 908	B1208
15 Scapient	03 860 352	B1197	
16 MgClO ₄ (Quartz Chips 1:1 (MgClO ₄))	03 860 352	B1101	
(Quartz Chips)	03 679 907	B1214	

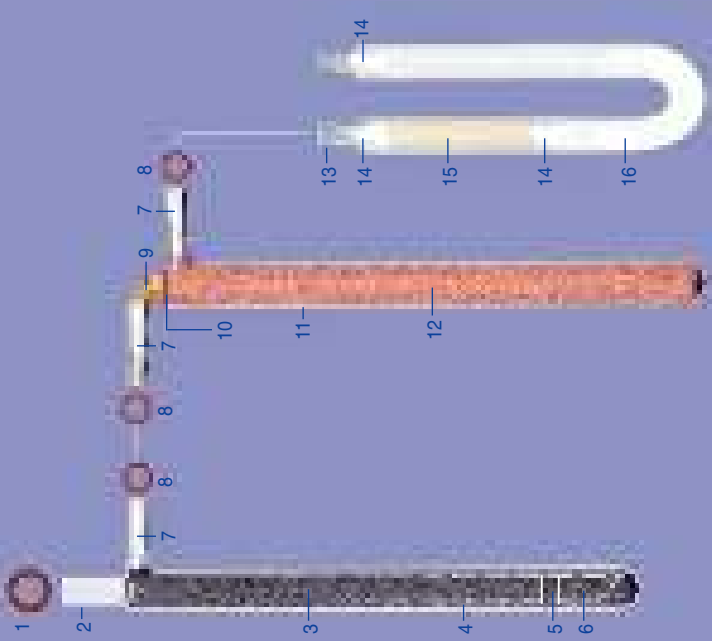

N DETERMINATION

Product	Qty	Elementar no	Cat no
1 O-ring, upper	03 854 814	E1055	C3019
2 Combustion Tube	22 133 210/3	C3019	B1214
3 Copper Oxide Wires	03 679 905	B1218	B1043
4 Inner tube containing: Nickel Gauze Receptacle	22 127 313	D6001	C3020
5 Quartz Wool (inner tube)	10 mm	03 679 908	B1208
6 Cerium Oxide (inner tube)	30 mm	03 679 915	B1028
7 Silver Wool	2,5 g	22 131 365	B1231
8 O-ring	03 854 603	E1016	
9 Lead Chromate	6 g	03 679 914	B1207
10 Quartz Wool	5 mm	03 679 908	B1208
11 Reduction Tube	22 127 245	C3005	
12 Copper Wires	03 679 924	B1015	
13 Tube	22 160 294	C3007	
14 Quartz Wool	10 mm	03 679 908	B1208
15 Silica Gel - Blue	03 860 157	B1044	
16 Soda Lime	03 679 900	B1189	
17 Soda Lime/Quartz Chips 1:1 (Soda Lime)	03 679 900	B1189	
(Quartz Chips)	03 679 907	B1214	
18 Scapient	03 860 352	B1197	

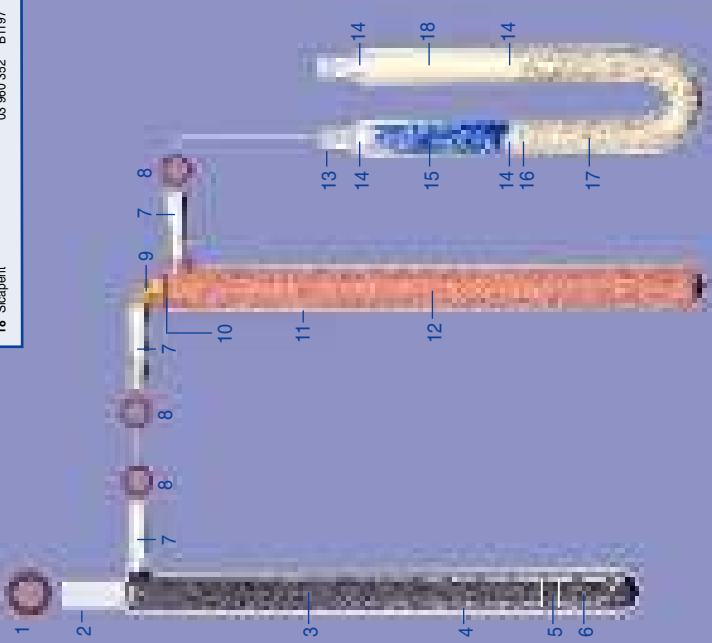

O DETERMINATION

Product	Qty	Elementar no	Cat no
1 Pyrolysis Tube	22 133 210/3	C3019	B1214
2 Quartz Chips	03 679 907	B1214	B1043
3 Carbon Granules	03 679 910	B1043	
4 Inner Tube, containing: Pyrolysis Tube Insert, silica	22 133 211/4	C3020	B1214
5 Quartz Chips (inner + outer tube)	03 679 907	B1214	B1231
6 Silver Wool	22 131 365	B1231	C3007
7 Tube	22 160 294	C3007	
8 Quartz Wool	10 mm	03 679 908	B1208
9 Soda Lime/Quartz Chips 1:1 (Soda Lime)	03 679 900	B1189	B1214
(Quartz Chips)	03 679 907	B1214	

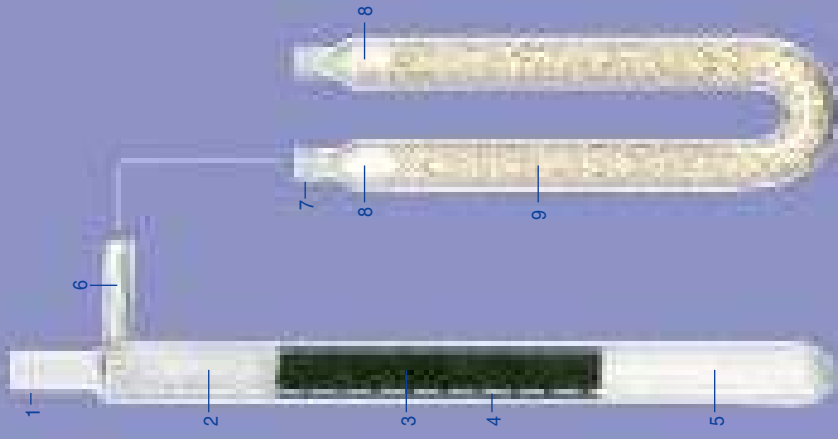

O DETERMINATION

Product	PE no.	Qty	Cat no.
1 O-ring	09902188		E1009
2 Oxygen Pyrolysis Tube	N2411235	25 mm	C2018
3 Quartz Wool	02401118	13 mm	B1102
4 Platinum Gauze	N2411273	1 mm	D7006
5 Quartz Wool	02401118	1 mm	B1102
6 Platinised Carbon	02400119	102 mm	B1005
7 Copper Wires	02401382	64 mm	B1015
8 Silver Gauze	N2410145	13 mm	B1037
9 O-ring	02401583		E1013
10 Filler Disc	02400137		E2011
11 Reduction Furnace Tube, empty	N2411300	51 mm	C2019
12 Scrubber Tube	02401118		B1102
13 Quartz Wool	N2411359	6 mm	C2021
14 Quartz Wool	02401118		B1102
15 Cobalt(II) Chloride (Carbosorb)	02400115	127 mm	B1018
16 Magnesium Perchlorate	02401119	25 mm	B1161
A Prepacked Oxygen Pyrolysis Tube			X2003

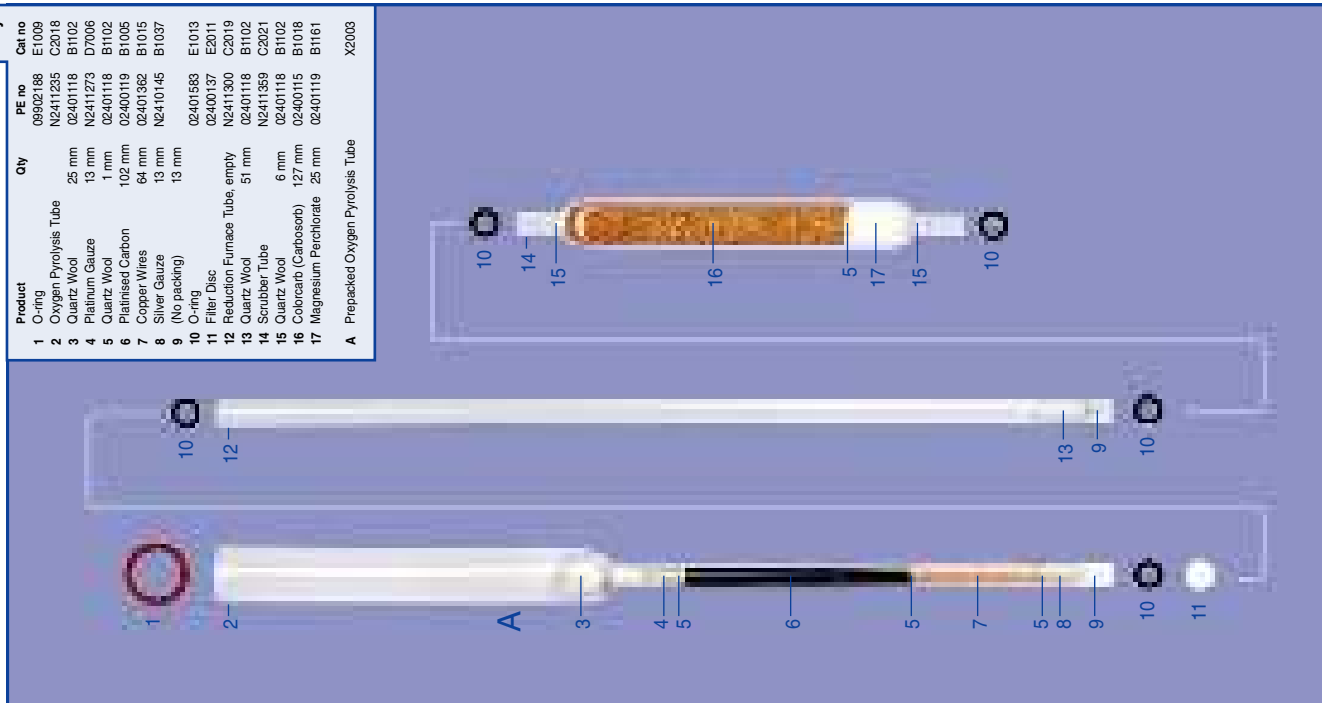

CHNS DETERMINATION

Product	PE no.	Qty	Cat no.
1 O-ring	09902188		E1009
2 Combustion/Reduction Tube	N2411514	32 mm	C2024
3 Quartz Wool	02401118	38 mm	B1102
4 EA6000 (Lungstic Oxide on Zirconia)	N2410278	38 mm	B1082
5 Quartz Wool	02401118	1 mm	B1102
6 Copper Wires, high purity	02401382	95 mm	B1035?
7 Quartz Wool	02401118	19 mm	B1102
8 O-ring	09901583		E1013
9 Filler Disc	02400137		E2011
10 Reduction Furnace Tube, empty	N2411300	25 mm	C2019
11 Quartz Wool	02401118		B1102
A Prepacked Reaction Tube			X2002

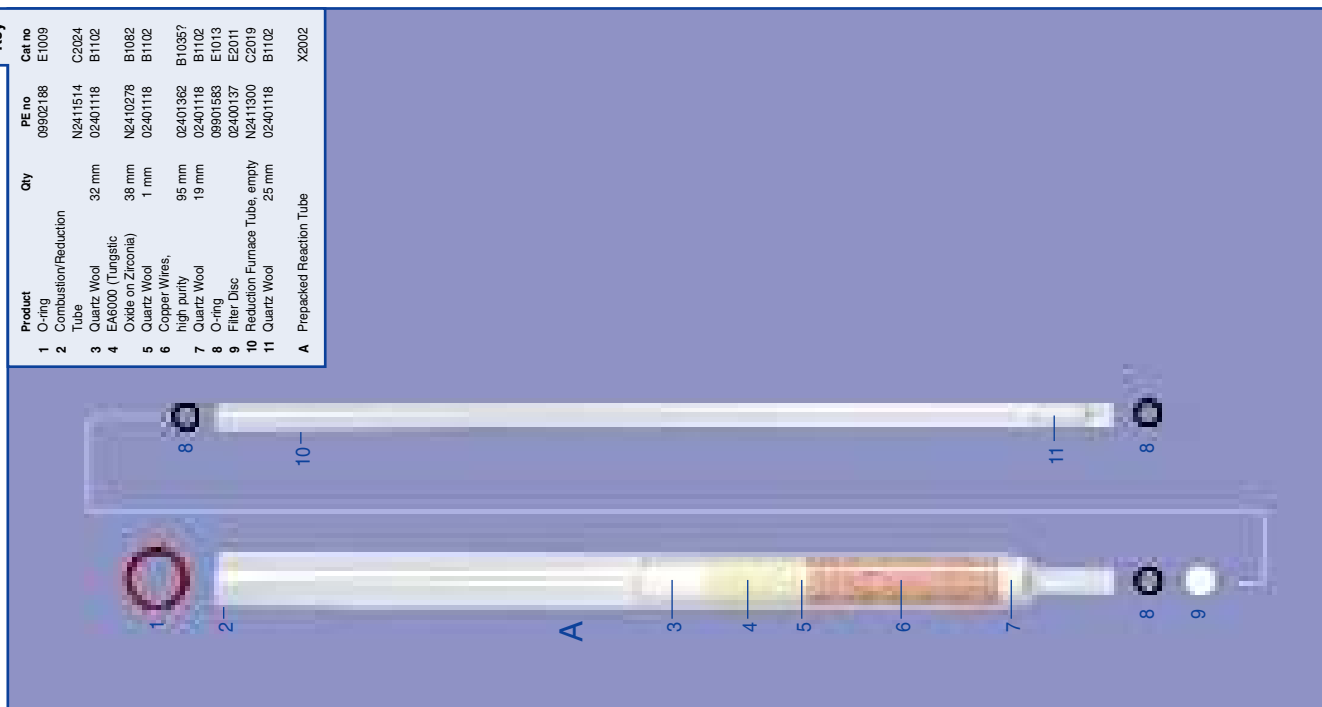

CHN DETERMINATION

Product	PE no.	Qty	Cat no.
1 O-ring, upper	09902188		E1009
2 Combustion tube	N2411284	38mm	C2015
3 Quartz Wool	02401118	51mm	B1102
4 EA1000(?)	02410092	1mm	B1179
5 Quartz Wool	02401118	1mm	B1102
6 Silver Tungstate on Magnesium Oxide	02401344	51mm	B1036
7 Silver Vanadate	02401117	25mm	B1009
8 Silver Wool	02401118	6mm	B1102
9 Silver Gauze	N2410145	13mm	B1037
10 O-ring	02401583		E1013
11 Filler disc	02400137		E2011
12 CHN Reduction tube	N2411291	6mm	C2016
13 Quartz Wool	02401118	13mm	B1102
14 Copper Oxide Wires	02401092	13mm	B1122
15 Copper Granules	02400117	240mm	B1084
A Prepacked Reaction Tube			X2000
B Prepacked Reduction Tube			X2001

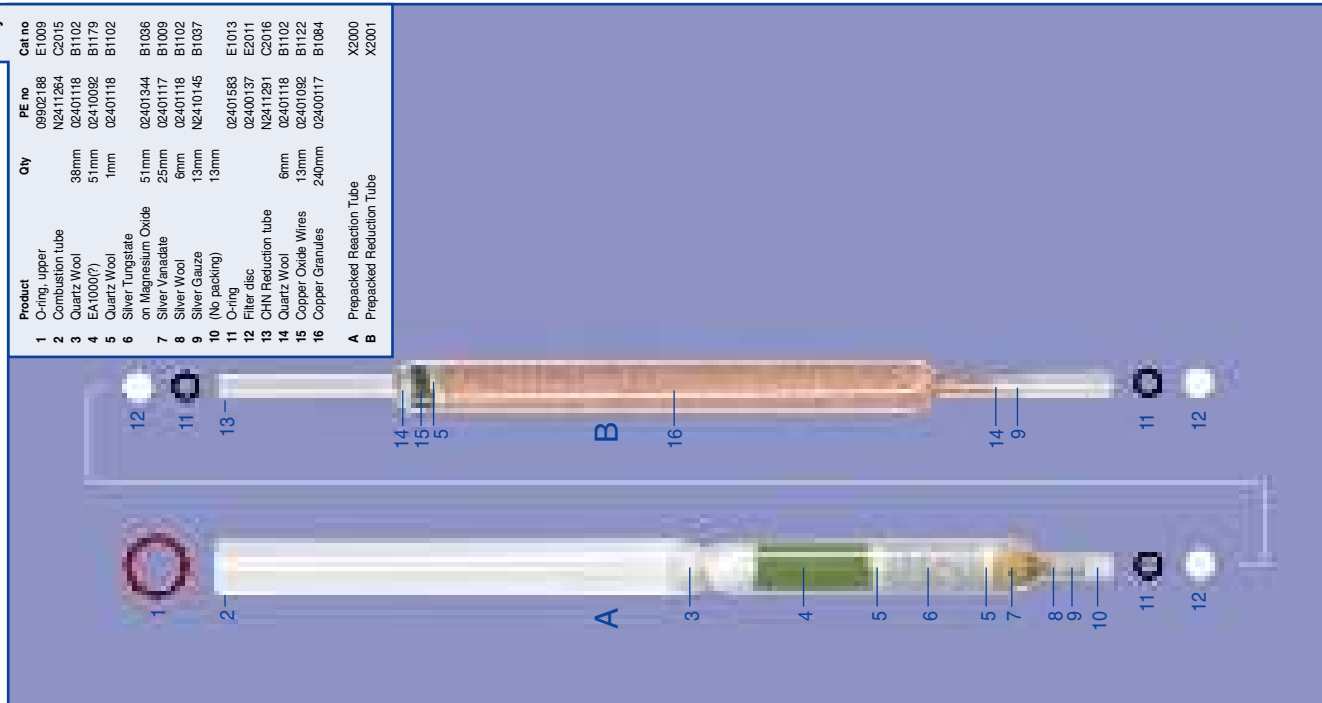

LECO® CHN-900

Key		Leco® no	Cat no
1	O-ring, upper	605-830	E1126
2	Oxidation Tube (Quartz)	605-875	C4002
3	Quartz Wool	502-177	B1102
4	Copper Oxide Wire	502-190	B1125
5	Quartz Wool	502-177	B1102
6	Silver Vanadate	502-226	B1009
7	(No packing)	605-828	E1035
8	O-ring, lower	605-830	E1037
9	O-ring, upper	502-304	B1015M
10	Copper Wires	OR 502-189	501-621
11	Copper Turnings	501-621	B1107
12	(No packing)		
A	Prepacked Tube CHN/Halogens		X3002
B	Prepacked Reduction Tube		X3001

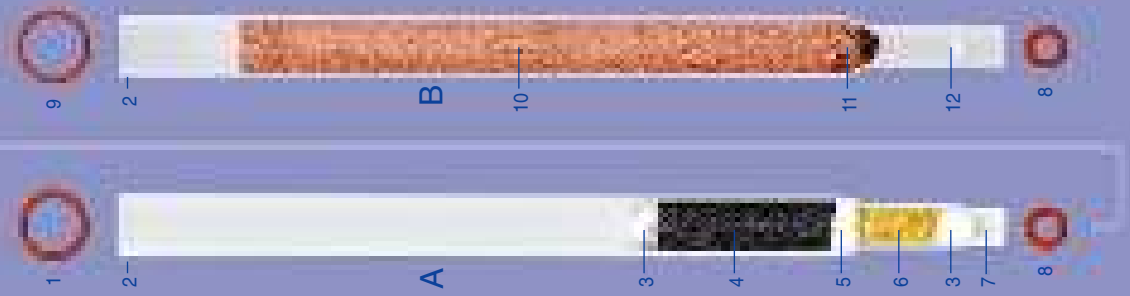

LECO® CHNS-932

Key		Leco® no	Cat no
1	O-ring, upper	605-830	E1126
2	Oxidation Tube (Quartz)	605-875	C4002
3	Quartz Wool	502-177	B1102
4	Copper Oxide Wire	502-190	B1125
5	Copper Sticks	502-304	B1015M
		OR 502-189	
6	Quartz Wool	502-177	B1102
7	(No packing)	605-828	E1035
8	O-ring, lower		
A	Prepacked Reaction Tube CHNS		X3004

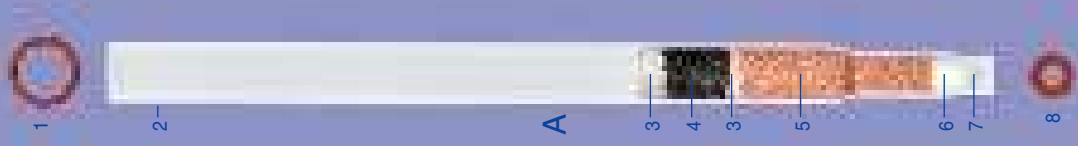

LECO® 900/932 GAS SCRUBBING TUBE

Key		Leco® no	Cat no
1	Reagent Tube	775-601	C4004
2	Glass Wool	501-081	B1166
3	Lecosorb	502-174	B1162
4	Anhydron	501-171	B1161
5	Screen Filler	775-306	E2235

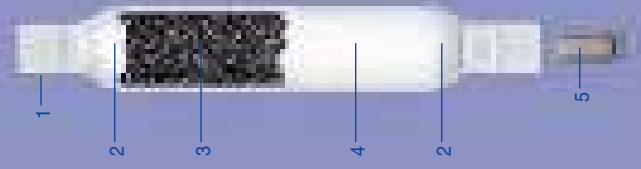

Thermo/CE/Fisons/Carlo Erba

CE Part *	Product	Pack	Cat. no.
1117400	Glassy Carbon Chips TC/EA	25g	C7002
1121310	Glassy Carbon Tube TC/EA	1	C7001
1121320	Ceramic Tube For TC/EA	1	C1101
1121351	TC/EA Graphite Tube	1	C7010
1132080	H2O Graphite Tube For TC/EA	1	C7011
1117332	Graphite Crucible For TC/EA	1	C7012
19001100	Consumables Kit 1106 S	1	X1002
19001201	Consumables Kit 1108/II CHN & O	1	X1004
19001202	Consumables Kit 1108/II CHNS & O	1	X1006
19001203	Consumables Kit 1108/II CHN	1	X1003
19001204	Consumables Kit 1108/II CHNS	1	X1005
19001300	Consumables Kit 1106 O	1	X1001
19001301	Consumables Kit 1108/II O	1	X1007
19002400	Consumables Kit 1500/II N	1	X1008
19002401	Consumables Kit 1500/II NC	1	X1009
19002402	Consumables Kit 1500/II NCS	1	X1010
19002406	Consumables Kit 2000 N	1	X1011
19002410	Cons Kit Flash EA1112 CHN	1	X1080
19002411	Cons Kit Flash EA1112 CHNS/NCS/S	1	X1081
19002412	Cons Kit Flash EA1112 CHNS/NCS/S	1	X1082
19002416	Cons Kit Flash EA1112 Oxygen	1	X1083
19003200	Consumables Kit 1106 CHN	1	X1000
19004128	TOC (Total Organic Carbon) Kit	1	E5010
19004205	Packed Reactor N NA2000 stainless steel	1	X1033
19004220	Flash EA1112 Cons Package A Solid	1	X1050
20500500	Forceps Stainless Curved	1	E2016
20503002	Sealing Device Liquid Samples	1	E5109
20901400	Furnace Amplifier Exchange	1	E2133
20901500	Oven Amplifier Exchange	1	E2132
23101008	Water Scrubber Tube, threaded	1	C1008
23903100	Timer - Program 1106/1400	1	E2012
24000700	Doping Vessel Chloropentane	1	C1042
24005300	Capsules Tin 5 x 3.5	100	D1003
24005400	Capsules Silver 6 x 4	100	D2007
24005405	Capsules Silver 8 x 5	100	D2009
24006400	Capsules Tin 8 x 5	100	D1009
24007200	Caps Smooth Tin 9 x 3.5 FB	100	D4035
24008015	Tin Discs - 30mm	100	D1066
24008810	Caps Smooth Tin 6 x 3 FB	100	D4001
24008820	Caps Smooth Tin 4.5 x 2 FB	100	D4019
24070005	Vials 2.5ml	100	E2300
24074020	Vials 10ml	100	E2310
24806400	Thermal Printer Paper Roll	1	E2067
25204400	Swarf Crucible Oxygen 1106	5	C1005
25204500	Swarf Crucible CHN 1106	5	C1004
25205000	Metal Swarf Crucible	1	D6005
25205010	SS Crucible Flash EA1112	1	D6050
25205011	High Alloy Crucible Flash EA1112	1	F5153
25208000	Pans Tin 10 x 10mm	100	D5055
25208020	Pans Silver 10 x 10mm	100	D5076
26007800	Separation Column Sulphur 0.8m	1	E3002
26007820	N2 Column Flash 1112 0.5m	1	E3022
26007900	Separation Column Oxygen 1m	1	E3001
26008000	Separation Column CHN 2m	1	E3006
26008200	Separation Column CHN 2m	1	E3000
26008205	Separation Column NC 3m	1	E3004
26008206	Separation Column CHNS NCS 2m	1	E3003
26008207	Separation Column CHNS NCS 2m	1	E3020
26008208	Separation Column CHNS NCS 2m PTFE	1	E3013
26018500	Separation Column Trace S	1	E3007
26070004	Separation Column NA2000	1	E3005
28104400	Halogens Trap 1106	1	C1021
28113060	Water/CO2 Scrubber NA2000	1	E2040
28113090	CO2 Scrubber 1500 Threaded	1	C1014
28113100	Scrubbing Tube Kit	1	E2350
28113106	Water/CO2 Scrubber	1	E2047
29000082	O Ring - Viton	2	E1059
29004045	Olive Stainless 2mm	1	E2100
29005046	O Ring - Nitrile	1	E1008
29013603	O Ring - Schott	10	E1021
29020640	Bottom O-Ring Reactor	1	E6052

CE Part *	Product	Pack	Cat. no.
29020649	Bottom O-Ring Reactor Flash	1	E6051
29020682	Top O-Ring Reactor Flash	1	E6050
29030042	O Ring Square Profile 1500-1	5	E1042
29030331	O Ring - Viton	10	E1001
29030567	O Ring - Viton	10	E1200
29032910	O Ring Square Profile 1108/1500-2	5	E1041
29034044	Aluminium Ferrules 1.6mm (1/16")	10	F4540
29050301	O Ring - Nitrile	10	E1022
29050304	O Ring - Nitrile	10	E1020
29050306	O Ring Square Profile 1106	5	E1043
29050567	O Ring - Viton	10	E1000
31302100	Bipneumatic Valve Diaphragm	1	E1011
31303200	Septum Liquid Injector	50	E2360
31303209	Septum Liquid Injector	50	E2361
33406200	Nickel Sheet 130 X 130mm	1	B1024
33801801	Molecular Sieve 3A	25gm	B1021
33821710	Copper Oxide Wire	50gm	B1002
33821900	Magnesium Perchlorate	25gm	B1019
33822000	Carbosorb 0.7-1.2mm	25gm	B1018
33822100	Copper Sulphate Hydrated	250gm	B1114
33822200	Silica Wool Fine	5gm	B1017
33822300	Silica Chips	50gm	B1008
33822400	Cyclohexanone2,4-Dinitrophenylhydrazone OAS	1gm	B2005
33822500	Benzoic Acid OAS	1gm	B2004
33822800	Cobaltous/Ic Oxide	25gm	B1001
33822900	Chromium Oxide	25gm	B1004
33823400	Diphenyl OAS	1gm	B2039
33823800	Nickelised Carbon 30%	5gm	B1086
33824400	Atropine OAS	1gm	B2002
33824500	Cobaltous/Ic Oxide Silver	25gm	B1000
33824600	Tungstic Oxide Granular	25gm	B1025
33824700	Nickel Oxide Granular	25gm	B1034
33825000	Nickel Wool	2gm	B1007
33825100	Sulphanilamide OAS	1gm	B2036
33825300	Isatin OAS	1gm	B2041
33835200	Benzylthiuronium Chloride OAS	1gm	B2007
33835210	2,5-Bis(5-tert-butyl-2-benzo-oxazol-2-yl)thiophene BBOT OAS	1gm	B2044
33835220	Methionine OAS	25gm	B2100
33835230	Soda Lime 1.7- 4mm	200gm	B1189
33835235	Soda Lime 1-2.5mm	100gm	B1211
33835240	Lubricant Standard	1	B2145
33835300	Copper Wires	100gm	B1015
33835310	Cu Wires - S Analysis	40gm	B1035
33835420	Tungstic Oxide On Alumina	25gm	B1031
33835430	Imidazol OAS	1gm	B2040
33836700	Acetanilide OAS	1gm	B2000
33837510	Vanadium Pentoxide Powder	10gm	B4001
33837520	Phenanthrene Enriched	1gm	B2113
33837530	Chromasorb W 30-60	25gm	B3017
33837540	Lead Oxide Red, Fine	1gm	B1039
33840000	Oxidation Catalyst NA2000	40gm	B1103
33840002	Urea OAS	10gm	B2130
33840019	Nicotinamide OAS	1gm	B2132
33840023	Aspartic Acid	10gm	B2139
33840024	Pasta Reference Material	10gm	B2140
34715401	Column Fitting 6 To 2 mm	1	E2035
34736100	Connector Block 4 Way	1	E2096
34739133	Tubing Coupling 2mm	1	E2095
34744100	Tubing Connector 2 To 2mm	1	E2094
35034108	Connector Tube Push Fit	1	E2034
35036103	Blanking Cap	1	E2099
35041101	Knurled Retaining Nut Brass	1	E2097
35045100	Blanking Nut Brass	1	E2050
35045400	Blanking Nut	1	E2036
35265000	Z Fold Chart Paper	2	E2068
35265100	Recorder Pen	1	E2069
36500204	Syringe 100ul	1	E2362
36500530	Syringe 500ul	1	E2364
36502019	Syringe 10ul	1	E2365
36707800	Bubble Flowmeter 50CC	1	E2038
38606035	Al Seal 20mm	50	E2311
38606040	Al Seal 11mm	100	E2301

Thermo/CE/Fisons/Carlo Erba (continued)

CE Part *	Product	Pack	Cat. no.
39102500	Tubing Stainless Steel 2mm x 3m	1	E2033
39103800	Reduction Tube Stainless	1	E2020
40523005	Purge Valve Autosampler	1	E2102
42001501	Tubing PTFE 2 x 1mm 5 Metres	1	E2030
42010000	Flexible Tubing	3m	E4404
42501400	Flow Control 1106 Exchange	1	E2131
42506800	Pressure Reg 1106 Exchange	1	E2130
46800650	Packed Reduction NC/N	1	X1043
46800650	Packed Reduction NC/N	1	X1014
46800660	Packed Reactor N NA2000	1	X1013
46800900	Reaction Tube 1106 Transparent	1	C1000
46801000	Reduction U Tube Silica	1	C1003
46801600	Reaction Tube 1500 Transparent	1	C1002
46801700	Reaction Tube Translucent 1500	1	C1012
46802005	Packed Reactor CHNS/NCS/S	1	X1012
46802006	Packed Reaction/Reduction CHN	1	X1034
46802007	Packed Combustion/Reduction CHNS/NCS/S	1	X1152
46802008	Prepacked Reactor EA1112 N/Protein	1	X1150
46820000	Reaction Tube 1108/1500 II Translucent	1	C1023
46820001	Reaction Tube Heavy Wall	1	C1078
46820020	Reaction Tube 1108/1500 II Transparent	1	C1022
46820030	Reaction Tube 1108 Translucent	1	C1019
46820040	Liquid Injection Tube	1	C1046
46820050	Reaction Tube Stainless NA2100	1	E2159
46820070	Reaction Tube Flash	1	C1069
46820075	High Alloy Reactor Flash EA1112	1	F5150

*CE Part: The use of CE part numbers is intended for convenience only, and does not imply that the products are of CE origin. All Elemental Microanalysis products are guaranteed to be of high quality and are deemed to be suitable alternatives.

Leco®

Leco® Part ¹	Product	Pack	Cat. no.
190-423	Screw Lance Assembly FP-528	4	E2201
190-427	Screw Zn Plate	1	E2185
190-865	Screw Nylon	1	E2163
501-001	Coal Std 0.3%	50gm	B2300
501-005	Coal Std 1%	50gm	B2304
501-014	Coal Std 1.5%	50gm	B2305
501-015	Coal Std 0.85%	50gm	B2303
501-022	Coal Std 3.5%	50gm	B2309
501-034	Calcium Carbonate	50gm	B2250
501-045-125	Ceramic Crucibles	10	C4034
501-046	Sucrose OAS	25gm	B2121
501-053	Acetanilide OAS	5gm	B2114
501-059	Caps Smooth Tin 18 X 5 RB	100	D4003
501-062	Boat Puller Assembly	1	E2768
501-077	Iron Chip Accelerator	908gm	B1195
501-081	Glass Wool Borosilicate	454gm	B1166
501-081	Glass Wool Rope Borosilicate	454gm	B1266
501-130	Coal Std 4%	50gm	B2310
501-171	Emadron 14-25 Mesh	454gm	B1161
501-184	Coal Std 5%	50gm	B2311
501-241	Silicone Grease	100gm	E2158
501-426	Combustion Aid Solids	454gm	B1185
501-427	Combustion Aid Liqds	454gm	B1186
501-520	Coal Std 3%	50gm	B2308
501-561	Soy Bean Meal OAS	30g	B2271
501-563	Corn Meal	30g	B2270
501-571	Copper Capsules 18 X 6 PRB	100	D4100
501-608	Quartz Wool Wadding	200gm	B1522
501-609	Furnace Reagent	100gm	B1191
501-614	Spatula	1	E2462
501-621	Copper Turnings Fine	200gm	B1107
501-964	Coal Std 6%	50gm	B2312
501-967	Extreme Pressure Oil Sulphur Range 2%	118ml	B2336
501-968	Extreme Pressure Oil Sulphur Range 3%	118ml	B2337
501-969	Extreme Pressure Oil Sulphur Range 4%	118ml	B2338
502-023	Filling Funnel	1	C4027

Leco® Part ¹	Product	Pack	Cat. no.
502-040	Caps Smooth Tin 18 x 6 RB	100	D4007
502-040-100	Caps Smooth Tin 18 x 6 RB	1000	D4015
502-049	Nitrogen Catalyst Pellets	50gm	B1061
502-055	Orchard Leaves Standard	20g	B2141
502-071	High Sulphur Residual Oil Sulphur Range 30%	118ml	B2230
502-085	Zinc Sulphide Standard	50gm	B2260
502-167	Caps Smooth Tin 20 x 8 RB	100	D4009
502-174	Emasorb A 14-25 Mesh	500gm	B1162
502-176	Emasorb B 7-14 Mesh	500gm	B1164
502-177	Silica Wool Fine	50gm	B1102
502-181	Tungstic Oxide Granular	60gm	B1217
502-186	Tin Foil Cones	100	D9001
502-188	Aluminium Oxide Pellets	200gm	B1163
502-189	Copper Wires	100gm	B1015M
502-190	Copper Oxide Wires	100gm	B1125
502-202	Coal Std 0.5%	50gm	B2301
502-203	Stearic Acid OAS	5gm	B2102
502-204	3,5-Dinitrobenzoic Acid OAS	5gm	B2118
502-205	Caffeine OAS	5gm	B2104
502-206	Capsules Silver 4 x 3.2	500	D2000
502-207	Cystine OAS	5gm	B2105
502-208	Sulphanilamide OAS	1gm	B2036
502-209	Sulphamethazine OAS	5gm	B2106
502-226	Silver Vanadate Reagent	10gm	B1009
502-227	Capsules Tin 4 x 3.2	500	D1000
502-272	Corn Gluten OAS	30g	B2272
502-273	Alfalfa OAS	30g	B2273
502-275	Rye Flour OAS	30g	B2275
502-276	Oatmeal OAS	30g	B2276
502-277	Barley OAS	30g	B2277
502-278	Rice OAS	30g	B2278
502-283	Adsorbant Discs 3.5mm	100	E2105
502-304-500	Copper Wires Pound Pack	454gm	B1083M
502-310	Iron Wool	454gm	B1165
502-338	Cellulose Capsules, Small	400	D9004
502-359	Magnesium Oxide Beads	200gm	B1190
529-026	Ceramic Crucibles	50	C4039
589-305	Seal	1	E1132
589-551	O Ring	1	E1112
601-132	Comb U Tube CHN800	1	C4330
601-387	Cooling Plate	1	E2165
601-390	Furnace Filter Tube	1	C4037
601-437	Catalyst Heater Tube	1	C4023
601-442	O Ring	1	E1101
601-483	Printer Paper	1	E2152
601-484	Printer Ribbon Cartridge	1	E2153
601-504	O Ring	1	E1103
601-684	O Ring	1	E1344
601-691	Pinch Valve Tubing	ft	E2150
601-876	Cylinder Brass	1	E2183
601-883	Sealing Piston	1	E2238
601-939	O Ring	1	E1102
601-963	Caps Smooth Tin 4 x 3.5 FB	100	D4032
601-981	Side Arm Brush	1	E2154
602-605	Tube Fitting Nylon	1	E2181
602-672	Spring Dosing Valve	1	E2167
603-350	O Ring Installation Tube	1	E2464
604-541	Lance	1	C4033
605-828	O Ring	1	E1105
605-830	O Ring	1	E1126
605-875	Combustion Tube	1	C4002
606-121	Sample Drop Plate SS	1	E2230
608-130	Inner Pyrolysis Tube	1	C7000
608-342	Inner Silica Tube	1	C4053
608-344	Outer Ceramic Tube	1	C4052
608-379	Quartz Wool Strips	10	B1192
608-505	Inner Ceramic Tube	1	C4059
614-961-110	Porous Crucibles (Pack 10)	1	C4065
614-962	Oxygen Lance	1	C4066
616-108	Combustion Tube FP528	1	C4057
616-138	O-Ring Combustion Tube FP528	1	E1140
616-146	Oxygen Lance	1	C4051

Leco® (continued)

Leco® Part ¹	Product	Pack	Cat. no.
616-147	Lance Assembly Complete	1	E2199
616-504	Particle Filter	1	E2369
617-136	O Ring	1	E1345
617-548	Reagent Tube	1	C4332
502-226	Combustion Tube Truspec	1	C4338
760-224	O Ring	1	E1127
761-929	Crucible Tong	1	E2471
763-265	Glass Wool Borosilicate	227gm	B1167
763-265	Glass Wool Rope Borosilicate	227gm	B1267
763-379	O Ring	1	E1107
765-976	O Ring	1	E1133
767-757	Coal Std 2%	50gm	B2306
767-758	Coal Std 2.5%	50gm	B2307
767-759	Coke Standard Sulphur Range 0.9%	50gm	B2316
768-980	Filter	1	E2151
770-764	Paper Roll SC32/132/232	1	E2244
770-778	Printer Ribbon	1	E2237
771-030	Reagent Tube	1	C4032
771-407	O-Ring	1	E1311
772-269	O Ring	10	E1109
772-520	O Ring	1	E1110
772-738	O Ring	1	E1111
772-910	O Ring	1	E1100
773-661	Tube Fitting Brass	1	E2182
773-913	O Ring	1	E1114
774-283	O Ring	1	E1129
774-368	Reagent Tube 6"	1	C4337
774-425	O Ring	1	E1342
774-613	O Ring	1	E1130
775-306	Secondary (Screen) Filter	1	E2235
775-601	Reagent Tube	1	C4004
775-880	Filter Tube	1	C4005
776-279	Catalyst Tube	1	C4006
776-283	Lance	1	C4025
776-284	O Ring	1	E1115
776-286	Comb U Tube CHN600	1	C4331
778-114	O Ring	1	E1131
778-116	O Ring	1	E1116
778-120	Gasket	1	E1125
780-899	Honeycomb Ceramic	1	C4058
780-911	Reduction Tube	1	C4020
781-585	Thermocouple Type S	1	E2371
782-079-110	Ceramic Stop High Flow	1	C4061
783-189	O-Ring	1	E1329
783-275	Lance Holder Block	1	E2197
783-276	Lance Holder Cover	1	E2198
783-608	Anhydrous Tube (Large)	1	C4336
783-897	O-Ring	1	E1328
UK-7753	Crucible Transparent Silica (Silica version of 529-026)	50	C4046

¹Leco® Part: The use of Leco® part numbers is intended for convenience only, and does not imply that the products are of Leco® origin. All Elemental Microanalysis products are guaranteed to be of high quality and are deemed to be suitable alternatives.

Perkin Elmer

PE Part ²	Product	Pack	Cat. no.
0240-0090	Boat Platinum 9x4x2.5mm+Tab	1	D5005
0240-0113	Ag Oxide/Ag Tungstate Cp	25gm	B1055
0240-0115	Carbosorb 0.7-1.2mm	100gm	B1236
0240-0117	Copper Granules Pound Pack	454gm	B1084
0240-0118	Tin Powder	10gm	B4002
0240-0119	Platinised Carbon 10% 0.2-0.85	5gm	B1005
0240-0132	Silver Oxide Fine Powder	1gm	B4006
0240-0133	8-Hydroxyquinoline OAS	1gm	B2020
0240-0137	Filter Disc 2400	12	E2011
0240-1092	Copper Oxide Wire	250gm	B1122
0240-1117	Silver Vanadate Reagent	10gm	B1009
0240-1118	Silica Wool Fine	5gm	B1017

PE Part ²	Product	Pack	Cat. no.
0240-1119	Magnesium Perchlorate	500gm	B1081
0240-1120	Benzoic Acid OAS	5gm	B2047
0240-1121	Acetanilide OAS	1gm	B2000
0240-1217	Scrubbing Tube 240ABC/CEC	4	C2004
0240-1225	Combustion Tube 240ABC	1	C2000
0240-1226	Reduction Tube 240A	1	C2001
0240-1230	Cobalt Oxide Fine Powder	10gm	B4005
0240-1238	Tungstic Oxide Powder	10gm	B4000
0240-1293	O Ring - Nitrile	2	E1015
0240-1321	Magnetic Ladle 240ABC/CEC	1	C2003
0240-1338	Benzylthiuronium Chloride OAS	1gm	B2007
0240-1343	Vanadium Pentoxide Powder	10gm	B4001
0240-1344	Ag Tungstate/Mg Oxide	100gm	B1036
0240-1347	Cyclhxn24Dnphhydrzn OAS	1gm	B2005
0240-1356	U Tube Oxygen 240ABC/CEC	1	C2008
0240-1359	Pyrolysis Tube Oxygen 240A	1	C2005
0240-1362	Copper Wires Pound Pack	454gm	B1083
0240-1369	Combust Tube Sulphur 240ABC	1	C2006
0240-1370	Reduction Tube Sulphur 240A	1	C2007
0240-1371	U Tube Sulphur 240ABC	1	C2010
0240-1372	Scrubber Tube Sulphur 240ABC	1	C2009
0240-1573	Reduction Tube 240BC/CEC	1	C2002
0240-1581	O Ring - Viton	10	E1007
0240-1582	O Ring - Nitrile	10	E1006
0240-1583	O Ring - Viton	10	E1013
0240-1673	Comb Tube 240 Autosampler	1	C2013
0240-1724	Ladle Autosampler 240ABC	1	C2023
0240-1961	Reduction Tube Sul 240BC/CEC	1	C2012
0240-1962	Pyrolysis Tube Oxygen 240BC	1	C2017
0240-1963	Oxidation Tube Oxy 240BC/CEC	1	C2011
0240-2133	O Ring - Viton	1	E1019
0497-8544	Capsules Tin 8 x 5	100	D1009
0990-2017	O Ring - Nitrile	10	E1005
0990-2048	O Ring - Nitrile	1	E1010
0990-2123	O Ring - Nitrile	2	E1014
0990-2188	O Ring - Silicone	10	E1009
N241-0092	Chromium Oxide	50gm	B1179
N241-0145	Silver Gauze 12.5 x 150mm	1	B1037
N241-0154	Reduction Tube 2400	5	C2039
N241-0155	Capsules Tin 6 x 4 Clean	10 x 96	D1112
N241-0164	Silver Vanadate Reagent	100gm	B1142
N241-0165	Ag Tungstate/Mg Oxide	500gm	B1145
N241-0166	Chromium Oxide	100gm	B1099
N241-0212	Comb Tube 2400/2410 Series Quartz	5	C2038
N241-0278	Tungstic Oxide/Zirconium Oxide	50gm	B1082
N241-0324	Cystine OAS	5gm	B2105
N241-0325	Edta Standard	100gm	B2137
N241-0330	Combustion Tube CHNS 2400/2410	5	C2028
N241-0501	Sulphamic Acid OAS	1gm	B2017
N241-0512	Consumable Kit CHNS 2400	1	X2010
N241-0518	Carbosorb 0.7-1.2mm	200gm	B1100
N241-1235	Pyrolysis Tube, 2400 Oxygen	1	C2018
N241-1255	Capsules Tin 6 x 4 Clean	96	D1027
N241-1264	Combustion Tube 2400	1	C2015
N241-1273	Gauze Platinum 12 x 150mm	1	D7006
N241-1274	Retreiving Wire 2400	1	E2101
N241-1291	Reduction Tube 2400	1	C2016
N241-1300	Reduction Tube, 2400 Oxygen	1	C2019
N241-1333	Copper Plug With Flange	1	D6002
N241-1335	Vial Receptacle 2400 Nickel	1	D6000
N241-1359	Scrubber Tube 2410	1	C2021
N241-1362	Capsules Tin 8 x 5	250	D1008
N241-1364	Capsules Silver 6 x 4 Clean	96	D2027
N241-1401	Sleeve Slitted 2400	1	C2025
N241-1514	Combustion Tube 2400	1	C2024
N241-1527	Copper Granules 0.3 to 0.85	454gm	B1138
N520-3115	Pans Aluminium 6 x 3.75mm	100	D5085

²PE Part: The use of Perkin Elmer part numbers is intended for convenience only, and does not imply that the products are of Perkin Elmer origin. All Elemental Microanalysis products are guaranteed to be of high quality and are deemed to be suitable alternatives.

Europa

E Part ³	Product	Pack	Cat. no.
C1001001	Carbosorb 1.4-2.8mm	100gm	B1237
C1001002	Carbosorb 0.7-1.2mm	100gm	B1236
C1001004	Chromium Oxide	25gm	B1004
C1001005	Chromasorb W 30-60	10gm	B3015
C1001006	Copper Wires	100gm	B1015
C1001007	Copper Oxide Wires	100gm	B1125
C1001008	Magnesium Perchlorate Gran	100gm	B1101
C1001009	Nickel Sheet 130 x 130mm	1	B1024
C1001012	Reaction Tube Robo Transparent	1	C1040
C1001013	Reaction Tube Robo Translucent	1	C1041
C1001014	Reduction Tube Roboprep	1	C1030
C1001015	Scrubber Tube Roboprep	1	C1032
C1001016	Silica Wool Very Fine	10gm	B1208
C1001017	Silica Chips	50gm	B1008
C1001018	Silver Wool Unreeled	10gm	B1119
C1001019	Capsules Tin 8 x 5	250	D1008
C1001020	Capsules Tin 6 x 4	500	D1006
C1001021	Capsules Tin 12 x 5mm	200	D1010
C1001022	Capsules Tin 12 x 6mm	200	D1012
C1001023	Capsules Tin 20 x 8mm	100	D1011
C1001024	Tin Discs - 21mm	100	D1064
C1001025	Tungstic Oxide On Alumina	25gm	B1031
C1001026	Vanadium Pentoxide Powder	10gm	B4001
C1001036	Forceps Stainless Straight	1	E2017
C1001037	Forceps Stainless Curved	1	E2016
C1001038	Spatula Micro Stainless	1	E2000
C1001039	Caps Smooth Tin 5.5 x 3.5 FB	100	D4033
C1001042	Cu Wires - S Analysis	40gm	B1035
C1001045	Cell Well 96 Flat Bottom	1	E2044
C1001048	Sleeve Insert Europa 15OD x 180mm Open Both Ends	1	C1050
C1001070	Separation Column ANCA-SL/GSL	1	E3030
C1001071	Glassy Carbon Chips	25g	C7003
C1001072	Capsules Silver 6 x 4 Clean	250	D2028
C1001073	Capsules Silver 12.5 x 5	200	D2010
C1001076	Platinum Wire 0.125 x 1m	1m	D9100
C1001085	Capsules Tin 6 x 4 Light Weight	100	D1016
C1001086	Capsules Tin 6 x 4 Clean Light	100	D1035
C1001087	Tin Discs - 16mm	100	D1063
C1001088	Tin Discs - 11mm	100	D1060
C1001089	Capsules Silver 6 x 4	500	D2006
C1001090	Capsules Silver 6 x 4	100	D2007
C1001091	Capsules Silver 8 x 5	250	D2008
C1001092	Capsules Silver 8 x 5	100	D2009
C1001093	Capsules Silver 6 x 4 Clean	96	D2027
C1001094	Silver Discs - 16mm	100	D2063
C1001095	Capsules Alum 8 x 5 Clean	96	D3029
C1001096	Caps Smooth Tin 5.5 x 2 FB	100	D4000
C1001097	Caps Smooth Tin 6 x 3 FB	100	D4001
C1001098	Magnesium Perchlorate Ind	100gm	B1141
E1000608	Copper Gasket 64mm	1	E2780
E1000609	Copper Gasket 38mm	1	E2781
E1002527	Pt Cu Ox Gran 10%	2gm	B1030
E1002684	O Ring	1	E1421
E1002687	Scrubbing Tube S19	1	C1063
E1005669	O Ring	1	E1420

³E Part: The use of Europa part numbers is intended for convenience only, and does not imply that the products are of Europa origin. All Elemental Microanalysis products are guaranteed to be of high quality and are deemed to be suitable alternatives.

Exeter

EX Part ⁴	Product	Pack	Cat. no.
0210-0117	Copper Granules Pound Pack	454gm	B1084
0240-0090	Boat Platinum 9 x 4 x 2.5mm + Tab	1	D5004
0240-0090A	Boat Platinum 9 x 4 x 2.5mm + Tab	1	D5005
0240-0092B	Silver Gauze 12.5 x 150mm	1	B1037
0240-0113	Ag Oxide/Ag Tungstate on Chromosorb P	25gm	B1055
0240-0115	Carbosorb 0.7-1.2mm	25gm	B1018
0240-0117	Copper Granules	500gm	B1175
0240-0118	Tin Powder	10gm	B4002
0240-0119A	Platinised Carbon 10% 0.2-0.85	5gm	B1005
0240-0132C	Silver Oxide Fine Powder	1gm	B4006
0240-0133	8-Hydroxyquinoline OAS	1gm	B2020
0240-0137A	Filter Disc 2400	12	E2011
0240-0810A	Ceramic Sleeve 7 x 40mm	10	D6003
0240-1092	Copper Oxide Wire	50gm	B1002
0240-1117C	Silv Vanadate Reagent on Chromosorb A	10gm	B1059
0240-1118	Silica Wool Fine	5gm	B1017
0240-1119	Magnesium Perchlorate	25gm	B1019
0240-1120	Benzoic Acid OAS	1gm	B2004
0240-1121	Acetanilide OAS	5gm	B2114
0240-1147B	Gauze Platinum 12 x 150mm	1	D7006
0240-1217	Scrubbing Tube 240ABC/CEC	4	C2004
0240-1217B	Scrubbing Tube Large Diameter	1	C6026
0240-1226	Reduction Tube 240A	1	C2001
0240-1230	Cobalt Oxide Fine Powder	10gm	B4005
0240-1238	Tungstic Oxide Powder	10gm	B4000
0240-1255	Combustion Tube CHN CEC	1	C6000
0240-1293	O Ring - Nitrile	2	E1015
0240-1321A	Ladle With Cutout CEC	1	C6020
0240-1321B	Magnetic Ladle 240ABC/CEC	1	C2003
0240-1338	Benzylthiuronium Chloride OAS	1gm	B2007
0240-1343	Vanadium Pentoxide Powder	10gm	B4001
0240-1344C	Ag Tungstate/Mg Oxide on Chromosorb A	25gm	B1058
0240-1347	Cyclhn24Dnphhydrzn OAS	1gm	B2005
0240-1356	U Tube Oxygen 240ABC/CEC	1	C2008
0240-1369	Combustion Tube Sulphur CEC	1	C6006
0240-1370	Reduction Tube Sulphur 240A	1	C2007
0240-1371	U Tube Sulphur CEC	1	C6010
0240-1372	Scrubber Tube Sulphur CEC	1	C6009
0240-1573	Reduction Tube 240BC/CEC	1	C2002
0240-1581	O Ring - Viton	10	E1007
0240-1582	O Ring - Nitrile	10	E1006
0240-1583	O Ring - Viton	10	E1013
0240-1724	Ladle Autosampler 240ABC	1	C2023
0240-1961	Reduction Tube Sul 240BC/CEC	1	C2012
0240-1962	Pyrolysis Tube Oxygen CEC	1	C6017
0240-1963	Oxidation Tube Oxy 240BC/CEC	1	C2011
0240-2061A	Ladle For Refractories 240/CEC	1	C6021
0990-2017	O Ring - Nitrile	10	E1005
306-00001	Silicone Grease	100gm	E2158
316-00003	O Ring - Nitrile	1	E1032
316-00008	O Ring - Nitrile	1	E1033
318-00002	Capsules Tin 8 x 5	100	D1009
318-00002	Capsules Tin 8 x 5	250	D1008
318-00009	Connector Tube Drive Box CEC	1	C6011
650-00001	Anthracene OAS	1gm	B2003
650-00002	Stearic Acid OAS	1gm	B2031
650-00003	Cystine OAS	1gm	B2035
650-00004	1-Chloro-2,4-Dinitrobenzne OAS	1gm	B2010
650-00008	Universal Combustion Additive	1gm	B4007
650-00011	Copper Wires	100gm	B1015
650-00011-1	Copper Wires 3 x 100gm	300gm	B1091
650-00012	Copper Granules	100gm	B1013
6703-0376	Ladle Curved CEC	1	C6024
6703-0378	Combustion Tube CHN CEC	1	C6003
6703-0406	Pyrolysis Tube Oxygen CEC	1	C6019
6703-0410	Capsules Silver 6 x 4 Clean	96	D2027
6703-0411	Capsules Alum 5 x 3.5	500	D3001
6703-0413	Capsules Tin 6 x 4	500	D1006
6703-0414	Caps Smooth Tin 5.5 x 3.5 RB	100	D4023
6703-0416	Ag Capsules Smooth Wall 9 x 3.5	100	D4101

Exeter (continued)

EX Part ⁴	Product	Pack	Cat. no.
6703-0418	Caps Smooth Tin 6 x 3 FB	100	D4001
6703-0499	Capsules Nickel 8 x 5mm 1mm Hole	250	D3503
6703-0500	Aluminium Squares - 30 x 30mm	100	D3081
6703-0503	Ladle Straight CEC	1	C6022
6703-0514	Combustion Tube CHN CEC	1	C6001
6703-0565	Pyrolysis Tube Oxygen CEC	1	C6018
6703-0580	Combustion Tube Sulphur CEC	1	C6008
6703-0581	Combustion Tube Sulphur CEC	1	C6007
6703-0584	Ladle Anti-Jetting CEC	1	C6023
6703-0585	Combustion Tube CHN CEC	1	C6002
6703-0589	Ladle Small Diameter CEC	1	C6025

⁴EX Part: The use of Exeter part numbers is intended for convenience only, and does not imply that the products are of Exeter origin. All Elemental Microanalysis products are guaranteed to be of high quality and are deemed to be suitable alternatives.

Costech

C Part ⁵	Product	Pack	Cat. no.
011001	Chromium Oxide Granular 0.85 to 1.7mm	50gm	B1179
011002	Cobaltous/ic Oxide Granular 0.85 to 1.7mm	25gm	B1001
011005	Copper Wires for S analysis, high purity, reduced 4 x 0.5mm	40gm	B1035
011007	Cobaltous/ic Oxide Silvered Granular 0.85 to 1.7mm	25gm	B1000
011008	Tungstic Oxide Granular 0.85 to 1.7mm	25gm	B1025
011009	Tungstic Oxide on Alumina Granular 0.85 to 1.7mm	25gm	B1031
011013	Copper Wires 3 x 100gm pack, coarse wires, reduced 6 x 0.65mm	300gm	B1213
011014	Copper Wires Coarse Wires Reduced 6 x 0.65mm	100gm	B1016
011016	Chromium Oxide on Alumina Granular 0.85 to 1.7mm	50gm	B1131
011017	Copper Wires for S analysis, high purity, reduced 4 x 0.5mm	100gm	B1177
011018	Nickelised Carbon Wool	5g	B1242
011022	Copper Wires Fine Wires Reduced 4 x 0.5mm	100gm	B1015
021020	Carbosorb Granular 0.7 to 1.2mm CO2 Absorbant	100gm	B1236
021022	Magnesium Perchlorate Granular 0.7 to 1.2mm H2O absorbant	100gm	B1101
021024	Nickel Wool Fine Wire	2gm	B1007
021025	Silica (Quartz) Chips Granular 0.85 to 1.7mm	50gm	B1008
021026	Silica (Quartz) Wool Very Fine	5gm	B1017
021030	Soda Lime Granular 1.0 to 2.5mm CO2 Absorbant	100gm	B1211
021035	Silica (Quartz) Wool Very Fine	10gm	B1208
031040	Acetanilide OAS	1gm	B2000
031042	Atropine OAS	1gm	B2002
031043	Benzoic Acid OAS	1gm	B2004
031044	Cyclohexanone2,4dinitrophenylhydrazone	1gm	B2005
031046	Sulphanilamide OAS	1gm	B2036
031047	2,5-(Bis(5-tert-butyl-2-benzo-oxazol-2-yl) thiophene (BBOT) OAS	1gm	B2044
031048	Methionine OAS	25gm	B2100
041060	Tin Capsules Pressed, Standard Weight 3.5 x 5	100	D1003
041061	Tin Capsules Pressed, Standard Weight 8 x 5mm	100	D1009
041062	Smooth Wall Tin Capsules Flat Base 6 x 3mm	100	D4001
041063	Smooth Wall Tin Capsules Flat Base 5 x 2mm	100	D4042
041065	Smooth Wall Tin Capsules Flat Base 9 x 3.5mm	100	D4035
041066	Silver Capsules Pressed 3.5 x 5mm	100	D2003
041067	Silver Capsules Pressed 8 x 5mm	100	D2009
041070	Tin Capsules Pressed, Standard Weight 6 x 4mm	500	D1006
041070	Tin Capsules Pressed, Standard Weight 6 x 4mm	100	D1007
041072	Silver Capsules Pressed 6 x 4mm	100	D2007
041073	Tin Weighing Pans Pressed, Standard Weight 10 x 10mm	100	D5055
041074	Tin Capsules Pressed, Standard Weight 5 x 3.5mm	500	D1002
041077	Tin Capsules Pressed, Standard Weight 8 x 5mm	250	D1008
051080	Separation Column CHNS, NCS	1	E3003
051081	Separation Column CHN	1	E3000
051082	Separation Column NC	1	E3004
051083	Separation Column Sulphur	1	E3002
051084	Separation Column Oxygen	1	E3001
051085	Separation Column NC 4m	1	E3008
051088	Separation Column Oxygen 2m	1	E3016
061104	Reaction Tube Transparent Silica	1	C1022
061105	Reaction Tube Translucent Silica	1	C1023
061106	Seal Viton Rubber Chamfered Square Profile	5	E1041

C Part ⁵	Product	Pack	Cat. no.
061110	Prepacked Reactor Tube, Translucent Silica	1	X1012
061112	Prepacked Reaction Tube NCH, N, NC Translucent Silica	1	X1015
071120	Scrubber Tube Water Threaded, Borosilicate Glass	1	C1008
071121	Scrubber Tube Carbon Dioxide Threaded, Borosilicate Glass	1	C1014
071122	O Ring Schott Type Silicone/PTFE	10	E1021
080006	Forceps Stainless Steel Curved Points	1	E2016
080011	Tubing Stainless Steel 2 x 1mm x 3 metres	1	E2033
080012	Blue Flexible Tubing Polyurethane 5 x 3mm	3m	E4404
091107	Column Fitting 6 to 2mm Stainless Steel	1	E2035
071122/23	Cap Kit for Threaded Joints Caps & PTFE Backed Silicone Seals	2	C1020

⁵C Part: The use of Costech part numbers is intended for convenience only, and does not imply that the products are of Costech origin. All Elemental Microanalysis products are guaranteed to be of high quality and are deemed to be suitable alternatives.

Elementar

EL Part ⁶	Product	Pack	Cat. no.
3002607	Shaft Seal	1	E1555
22133213	Silver Boats 8 x 8 x 15mm	70	D5034
22133214	Silver Boats 9 x 10 x 20mm	42	D5035
03 001 118	Sulphanilic Acid OAS	5gm	B2147
03 002 252	O Ring Silicone	1	E1089
03 002 262	Platinum Catalyst	30gm	B1196
03 002 267	O Ring - Viton	1	E1075
03 651 011	Tubing Ptfе 5 x 3 mm 0.5m	1	E1058
03 653 103	O Ring - Silicone	1	E1063
03 653 118	O Ring - Silicone	1	E1085
03 654 505	O Ring - Silicone	1	E1086
03 654 603	O Ring - Silicone	10	E1016
03 654 615	O Ring - Nitrile	1	E1081
03 654 627	O Ring - Viton	1	E1073
03 654 629	O Ring - Silicone	1	E1066
03 654 701	O Ring - Silicone	1	E1082
03 654 772	O Ring - Viton	1	E1088
03 654 814	O Ring - Silicone	1	E1055
03 667 990	Sealing Ring	1	E1079
03 667 991	Sealing Ring	1	E1080
03 679 900	Emasorb A 0.8 - 1.6mm	200gm	B1115
03 679 900	Emasorb A 14-25 Mesh	500gm	B1162
03 679 901	Emadronе 14-25 Mesh	454gm	B1161
03 679 907	Silica Chips	100gm	B1214
03 679 908	Silica Wool Very Fine	10gm	B1208
03 679 910	Carbon High Purity Gran	5gm	B1043
03 679 914	Lead Chromate Granular	250gm	B1207
03 679 915	Cerium Dioxide Granular	100gm	B1219
03 679 924	Copper Granules	500gm	B1175
03 679 941	Quadring - Silicone	1	E1090
03 679 942	Acetanilide OAS	5gm	B2114
03 697 900	Carbosorb 0.7-1.2mm	25gm	B1018
03 951 619	Caps Smooth Tin 5.5 x 3.5 RB	100	D4023
03 951 620	Caps Smooth Tin 6 x 3 FB	100	D4001
03 960 157	Silica Gel	1kg	B1066
03 960 350	4-Nitroaniline OAS	1gm	B2015
03 960 352	Sicapent	500g	B1197
03 968 006	Vacuum Grease	100gm	E2240
05 000 043	O Ring - Silicone	1	E1062
05 000 086	Aluminium Oxide Wool	20gm	B1089
05 000 087	Ash Finger Ceramic Rapid N	1	C3030
05 000 088	Oxygen Lance 140 Mm Vario EL	1	C3011
05 000 092	O Ring - Kalrez	1	E1061
05 000 094	Gloves Elementar	Pair	E2505
05 000 095	O Ring - Viton	1	E1074
05 000 096	O Ring - Viton	1	E1072
05 000 140	O Ring - Nitrile	1	E1060
05 000 247	Seal Oxy Lance Vario EL/Rapid N 100mm	1	E1050
05 000 248	O Ring - Silicone	1	E1083
05 000 249	O Ring - Viton	1	E1067
05 000 311	Caps Smooth Tin 20 x 8 RB	100	D4009
05 000 312	Tin Capsules Smooth Wall 14 x 6.75	100	D4120
05 000 341	O Ring - Viton	1	E1053
05 000 353	Quadring - Nitrile	1	E1054
05 000 354	Oxygen Lance 150 mm Vario EL	1	C3012
05 000 359	O Ring - Viton	1	E1070

Elementar (continued)

EL Part ⁶	Product	Pack	Cat. no.
05 000 368	O Ring - Viton	1	E1071
05 000 369	O Ring - Viton	1	E1057
05 000 371	O Ring - Viton	1	E1076
05 000 372	O Ring - Viton	1	E1077
05 000 384	Quadrang - Nitrile	1	E1078
05 000 385	O Ring - Viton	1	E1068
05 000 400	Benzoic Acid OAS	5gm	B2047
05 000 416	O Ring - Viton	1	E1069
05 000 429	Tin Foil Cones	100	D9001
05 000 481	Tin Capsules Smooth Wall 11 x 4.75	250	D4121
05 000 658	Oxygen Lance 170 mm	1	C3013
05 000 699	Copper Wires	100gm	B1015M
05 000 814	Al Capsules Smooth Wall 7 x 3.2	250	D4111
05 000 815	Al Capsules Smooth Wall 9 x 3.5	250	D4110
05 000 816	Ag Capsules Smooth Wall 5.5 x 3.5	250	D4102
05 000 817	Capsules Silver 8.75 x 3.5	100	D2089
05 000 880	Manganese Dioxide	10gm	B1204
05 000 893	Silica Gel Drying Agent	100gm	B1044
05 000 900	Silica Chips	50gm	B1215
05 001 013	Gelatin Capsules 8 x 25	100	E2145
05 001 039	Copper Oxide Wire	250gm	B1122
05 001 059	Magnesium Perchlorate Ind	100gm	B1141
05 001 070	Cobaltous/ic Oxide	25gm	B1001
05 001 169	Phenylalanine OAS	25g	B2148
11 001 150/4	Combustion Tube Vario EL	1	C3009
11 001 170/4	Ash Finger Vario El 65mm	1	C3018
11 001 171/4	Support Tube 133 mm Vario EL	1	C3016
11 001 172/4	Support Tube 65 mm Vario EL	1	C3017
11 001 304/4	Pfite Plug Vario EL	1	E2037
11 001 308/4	Reduction Tube Vario EL	1	C3010
11 001 317/4	Ash Finger Silica 105mm	1	C3021
11 00-1331/4	Connecting Tube Silica	1	C3022
11 020 008	Tungstic Oxide Granular	60gm	B1217
11 020 017	Tungsten (VI) Oxide Powder 25g	25gm	B4013
12 001 009	Tin Boats 9 x 10 x 20	120	D5033
12 010 032	Tin Squares - 37 x 37mm (400 Pack)	400	D1116
12 010 033	Tin Squares - 50 x 50mm	100	D1115
22 127 245/3	Red Tube Heraeus CHN Rapid	1	C3005
22 127 313/4	Receptacle Insert Ni Gauze	1	D6001
22 131 365	Silver Wool 0.05mm	50gm	B1231
22 133 210/3	Pyrolysis Tube Vario EL	1	C3019
22 133 211/4	Pyrolysis Tube Insert Vario EL	1	C3020
22 133 212	Boats Silver 12 x 6 x 6	100	D5026
22 137 418	Boats Tin 12 x 4 x 4	1000	D5130
22 137 419	Boats Tin 12 x 6 x 6	500	D5131
22 137 420	Tin Boats 8 x 8 x 15	250	D5032
22 156 202/3	Comb Tube Heraeus CHN Rapid	1	C3004
22 156 919	Bubble Flowmeter 50CC	1	E2038
22 160 200/4	Drying Guard Tube	1	C3008
22 160 301/4	U Tube Complete Vario EL	1	C3015
34 001 339/4	U-Tube Large Rapid N GL18	1	C3038
50 008 467	Aluminium Oxide Spheres 2-4mm	40gm	B1090
88 895 805	Aspartic Acid	100gm	B2138

⁶EL Part: The use of Elementar part numbers is intended for convenience only, and does not imply that the products are of Elementar origin. All Elemental Microanalysis products are guaranteed to be of high quality and are deemed to be suitable alternatives.

Eurovector

EV Part ⁷	Product	Pack	Cat. no.
E10101	Chromium Oxide	25gm	B1004
E10102	Chromium Oxide on Alumina	50gm	B1131
E10103	Chrome Catalyst	100g	B1450
E10105	Cobaltous/ic Oxide	25gm	B1001
E10108	Copper Oxide Wires Coarse	100gm	B1234
E10109	Copper Oxide Wires	100gm	B1125
E10120	Copper Wires (Coarse)	50gm	B1046
E10121	Copper Wires (Coarse)	100gm	B1016
E10123	Copper Wires	100gm	B1015
E10130	Cu Wires - S Analysis - Coarse	40gm	B1040
E10142	Nickel Oxide Granular	25gm	B1034

EV Part ⁷	Product	Pack	Cat. no.
E10145	Nickelised Carbon 50% Lrge Gran	5gm	B1182
E10148	Oxidation Catalyst	40gm	B1103
E10152	Tungstic Oxide Granular	25gm	B1025
E10156	Tungstic Oxide On Alumina	25gm	B1031
E10160	Cobaltous/ic Oxide Silv	25gm	B1000
E10180	Lead Oxide Red, Fine	1gm	B1039
E10182	Vanadium Pentoxide Powder	10gm	B4001
E10184	Vanadium Pentoxide Powder	1g	B4010
E10502	Soda Lime 1-2.5mm	100gm	B1211
E10503	Carbosorb 0.7-1.2mm	100gm	B1236
E10504	Chromasorb W 30-60	25gm	B3017
E10505	Carbosorb 0.8-1.4mm	25gm	B1042
E10506	Magnesium Perchlorate	100gm	B1101
E10507	Magnesium Perchlorate	25gm	B1019
E10508	Molecular Sieve 3A	100gm	B1047
E10510	Nickel Wool	2gm	B1007
E10512	Silica Chips	100gm	B1214
E10513	Silica Chips	50gm	B1008
E10514	Silica Wool Fine	5gm	B1017
E10521	Glassy Carbon Chips	25g	C7003
E11001	Acetanilide OAS	1gm	B2000
E11002	4-Fluorobenzoic Acid OAS	1gm	B2013
E11003	Urea OAS	1gm	B2038
E11004	Anthracene OAS	1gm	B2003
E11005	Edta OAS	1gm	B2033
E11006	8-Hydroxyquinoline OAS	1gm	B2020
E11008	Atropine OAS	1gm	B2002
E11009	Cystine OAS	1gm	B2035
E11012	Bis(Trtbylnbzoxyl)Thpne OAS	1gm	B2044
E11016	Benzoic Acid OAS	1gm	B2004
E11020	Cyclhxn24Dnphhydrzn OAS	1gm	B2005
E11024	1-Chloro-2;4-Dinitrbenzne OAS	1gm	B2010
E11026	Methionine OAS	25gm	B2100
E11028	Sulphanilamide OAS	1gm	B2036
E11501	Separation Column CHNS NCS 2m	1	E3003
E11505	Separation Column CHN 2m	1	E3000
E11507	Separation Column CHNS NCS 2m PTFE	1	E3013
E11510	Separation Column NC 3m	1	E3004
E11515	Separation Column Sulphur 0.8m	1	E3002
E11520	Separation Column Oxygen 1m	1	E3001
E12001	Capsules Tin 5 x 3.5	500	D1002
E12003	Capsules Tin 5 x 3.5	100	D1003
E12005	Capsules Tin 8 x 5	100	D1009
E12007	Capsules Tin 8 x 5	250	D1008
E12010	Pans Tin 10 x 10mm	100	D5055
E12020	Caps Smooth Tin 5 x 2 FB	100	D4042
E12025	Caps Smooth Tin 6 x 3 FB	100	D4001
E12030	Caps Smooth Tin 9 x 3.5 RB	100	D4005
E12050	Capsules Silver 5 x 3.5	100	D2003
E12055	Capsules Silver 8 x 5	100	D2009
E12501	Reaction Tube 1106 Transparent	1	C1000
E12505	Reduction U Tube Silica	1	C1003
E12507	Ceramic Tube Eurovector	2	C1102
E12508	Reaction Tube Eurovector	2	C1084
E12509	Reaction Tube Eurovector	2	C1074
E12510	React. Tube Heavy Wall	1	C1099
E12512	Reaction Tube Modified	1	C1056
E12520	Reaction tube, quartz 20/6, transparent	1	C1083
E12525	Reaction tube, quartz 20/6, translucent	1	C1088
E12529	Glassy Carbon Tube	1	C7004
E13040	Prepacked Tube Eurovector CHNS/NCS/S	1	X1074
E13520	O Ring	10	E1500
E13525	O Ring	10	E1501
E13535	O Ring	2	E1503
E13536	O Ring	1	E1504
E13537	O Ring	1	E1505
E13538	O Ring	1	E1506
E13539	O Ring	1	E1507
E13540	O Ring	1	E1508

⁷EV Part: The use of Eurovector part numbers is intended for convenience only, and does not imply that the products are of Eurovector origin. All Elemental Microanalysis products are guaranteed to be of high quality and are deemed to be suitable alternatives.

LITERATURE REQUEST FAXBACK FORM

For full details of all the products we supply for your instrument please copy this page and fax it back to us.

+44 (0)1837 54544 or your local dealer:

Micro/CHN(OS) Instruments

- ThermoFinnigan **Flash EA™ 1112 CHNOS**
- ThermoFinnigan **Flash EA™ 1112 NC/S**
- ThermoFinnigan (Carlo Erba/Fison) **EA1110**
- ThermoFinnigan (Carlo Erba/Fison) **EA1108**
- ThermoFinnigan (Carlo Erba/Fison) **EA1106**
- ThermoFinnigan (Carlo Erba/Fison) **EA1102/1104**
- ThermoFinnigan (Carlo Erba/Fison) **NA2500 N/NC/NCS**
- ThermoFinnigan (Carlo Erba/Fison) **NA1500 (Series 1&2)**

- Perkin Elmer **2400**
- Perkin Elmer **240 Series ABC**
- Perkin Elmer **440**
- Perkin Elmer **2410**

- Exeter Analytical **(CEC) CE440**
- Exeter Analytical **(CEC) 240**

- Europa **Roboprep**
- Europa **Anca**
- Europa **Integra**

- Elementar (Foss Heraeus) **Vario EL**
- Elementar (Foss Heraeus) **CHN Rapid**

- EuroVector **EA3000**

- Leco® **CHN-900**
- Leco® **CHN-932**
- Leco® **CHN-1000**
- Leco® **CHN-2000**
- Leco® **CHN-600**
- Leco® **CHN-800**
- Leco® **Truspec CHN/CN**

- Costech **ECS 4010**

Catalogues

- Inorganic**
- Carbon/Sulphur**
- Nitrogen/Protein**

- Contract Analysis Service**

Name

Organisation

Address

Tel

Fax

E-mail



“the centre of excellence in elemental analysis”



Elemental Microanalysis Ltd

Hameldown Road

Okehampton Business Park

Exeter Road

Okehampton

Devon EX20 1UB

United Kingdom

Tel: +44 (0)1837 54446

Fax: +44 (0)1837 54544

E-mail: info@microanalysis.co.uk

www.microanalysis.co.uk